

Kolanko 06mm PUL-06



hitech

model	PU-PUL-06
producent	Hi-Tech
wąż	Ø 6 mm
typ	kolanko

typ szybkozłączki: kolanko

wąż: 6 mm

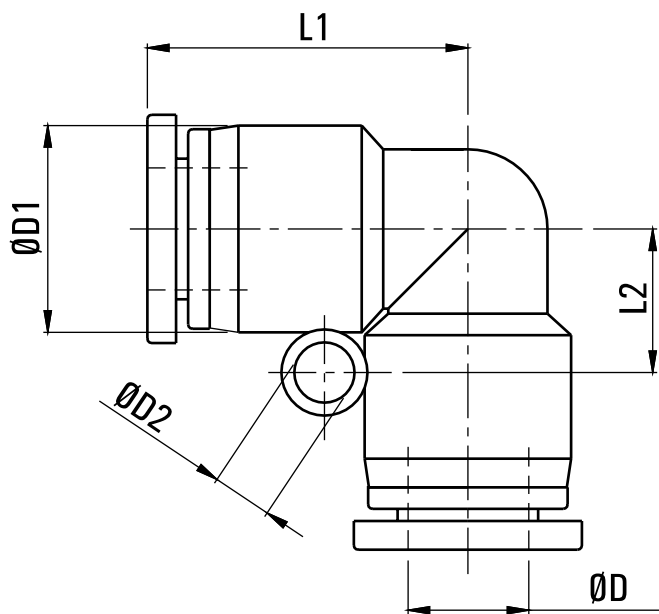

MODEL	ØD	ØD1	ØD2	L1	L2
PUL-04	4	11.5	3.2	19	7
PUL-06	6	13.5	3.2	19.2	8
PUL-08	8	15	3.2	22.5	10
PUL-10	10	19	4.2	27.8	12
PUL-12	12	21.5	4.2	29.5	13.5
PUL-16	16	26.5	-	33	-