

NARZĘDZIA PNEUMATYCZNE

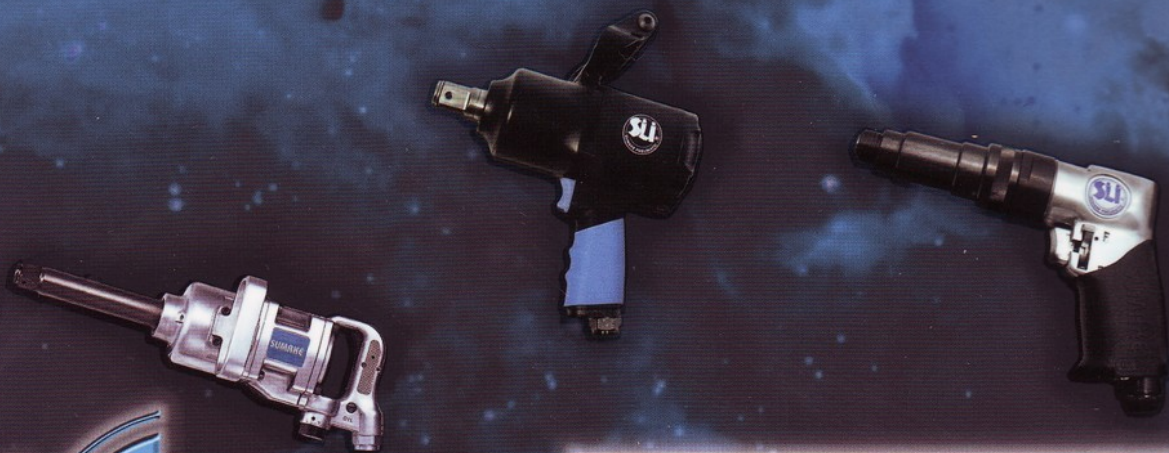

PNEUMATYKA



PNEUMATIG

www.pneumatig.eu

Spis treści

	Przemysłowe wkrętarki proste	3 - 4		Szlifierki kątowe; szlifierki trzpieniowe	2 5
	Przemysłowe wkrętarki katowe	5		Szlifierki trzpieniowe	2 6
	Przemysłowe wkrętarki pistoletowe	6 - 8		Szlifierki orbitalne ; oscylacyjne i liniowe	2 7
	Wkrętarki pistoletowe	9 - 10		Polerki	2 8
	Wiertarki pistoletowe kompozyt	1 1		Młotki igłowe	2 9
	Wiertarki pistoletowe ALU	1 2		Młotki wyburzeniowe i ścinaki	3 0
	Wkrętarki proste	1 3		Oprzyrządowanie do młotków	3 1
	Wiertarko - wkrętarko - gwinciarzki proste	1 3		Nitownice i zaciągarki do nitonakrętek Piły pneumatyczne	3 2
	Narzędzia impulsowe	1 4 - 1 6		Narzędzia specjalistyczne	3 3
	Automatyczne podajniki wkrętów	1 7		Zszywacze	3 4
	Cyfrowy miernik momentów ; Ramiona podporowe	1 8		Pozostałe narzędzia pneumatyczne	3 5
	Wiertarki z uchwytem 10 mm	1 9		Pistolety lakiernicze ; Aerografy	3 6
	Wiertarki z uchwytem 13 ; 16 ; 19 mm	2 0		Zwijadła ; Przewody spiralne	3 7
	Wkrętarki	2 1		Balansery	3 8
	Klucze pneumatyczne 3/8" ; 1/2" ; 3/4" ; 1"	2 2		Elementy uzdatniania sprężonego powietrza	3 9
	Klucze 1/2" ; 3/4" ; 1" ; 1 1/2"	2 3		Elementy uzdatniania sprężonego powietrza	4 0
	Klucze katowe 1/4" ; 3/8" ; 1/2"	2 4		Wkrętarki elektryczne	4 1 - 4 6

Push Start

Full-auto shut off air

- kompozytowa obudowa
- do pracy wielozmianowej
- zewnętrzna regulacja sprzęgła
- obroty L-R



Kolorowe oznakowanie momentu



Model	Obroty (obr/min)	Zakres regulacji momentu (Nm)	Masa (g)	Długość (mm)	Średnica	Poziom hałasu (dB)	Minimalna średnica węża przy ciśnieniu		Zużycie powietrza		Odchylenie standardowe (%)	Średnica wkrętu	
							6 kg/cm ³	5 kg/cm ³	cfm	m ³ /min		Do otworów samogwintujących	Do otworów gwintowanych
CP10	1000	0.05-0.2	480	180	31	70	5.0	6.35	7.0	0.20	±3	M1.0-M2.2	M1.1-M1.7
CP20	1000	0.1-0.8	480	180	31	70	5.0	6.35	7.0	0.20	±3	M1.7-M3.3	M1.3-M2.7
CP30	1800	0.3-1.7	480	180	31	74	5.0	6.35	10.0	0.28	±3	M2.2-M4.2	M1.7-M3.2
CP35	2200	0.3-2.0	480	180	31	74	5.0	6.35	10.0	0.28	±3	M2.4-M4.5	M2.0-M3.5
CP40	1000	0.5-3.0	480	180	31	74	5.0	6.35	10.0	0.28	±3	M2.8-M5.0	M2.3-M4.0
CP45	800	0.8-4.0	480	180	31	78	6.35	8.0	10.6	0.30	±3	M3.0-M5.7	M2.7-M4.4
CP48	1800	0.5-4.5	790	215	39	78	8.0	9.5	19.0	0.55	±3	M2.8-M5.8	M2.3-M4.7
CP50	1400	0.7-5.0	790	215	39	78	8.0	9.5	19.0	0.55	±3	M2.9-M6.0	M2.6-M4.9
CP55	1000	0.7-6.5	790	215	39	78	8.0	9.5	19.0	0.55	±3	M2.9-M6.4	M2.6-M5.4
CP60	550	1.5-9.5	790	215	39	78	8.0	9.5	19.0	0.55	±3	M4.1-M7.0	M3.3-M6.0
CP65	300	3.0-18.0	800	215	39	78	8.0	9.5	21.2	0.60	±3	M5.7-M9.5	M4.4-M7.5

Lever Start

Shut off air

- kompozytowa obudowa
- uruchamiana dźwignią
- do pracy wielozmianowej
- zewnętrzna regulacja sprzęgła
- obroty L-R



Kolorowe oznakowanie momentu



Model	Obroty (obr/min)	Zakres regulacji momentu (Nm)	Masa (g)	Długość (mm)	Średnica	Poziom hałasu (dB)	Minimalna średnica węża przy ciśnieniu		Zużycie powietrza		Odchylenie standardowe (%)	Średnica wkrętu	
							6 kg/cm ³	5 kg/cm ³	cfm	m ³ /min		Do otworów samogwintujących	Do otworów gwintowanych
CL10	1000	0.05-0.2	520	210	31	70	5.0	6.35	7.0	0.20	±3	M1.0-M2.2	M1.1-M1.7
CL20	1000	0.1-0.8	520	210	31	70	5.0	6.35	7.0	0.20	±3	M1.7-M3.3	M1.3-M2.7
CL30	1800	0.3-1.7	520	210	31	74	5.0	6.35	10.0	0.28	±3	M2.2-M4.2	M1.7-M3.2
CL35	2200	0.3-2.0	520	210	31	74	5.0	6.35	10.0	0.28	±3	M2.4-M4.5	M2.0-M3.5
CL40	1000	0.5-3.0	520	210	31	74	5.0	6.35	10.0	0.28	±3	M2.8-M5.0	M2.3-M4.0
CL45	800	0.8-4.0	520	210	31	78	6.35	8.0	10.6	0.30	±3	M3.0-M5.7	M2.7-M4.4
CL48	1800	0.5-4.5	820	245	39	78	8.0	9.5	19.0	0.55	±3	M2.8-M5.8	M2.3-M4.7
CL50	1400	0.7-5.0	820	245	39	78	8.0	9.5	19.0	0.55	±3	M2.9-M6.0	M2.6-M4.9
CL55	1000	0.7-6.5	820	245	39	78	8.0	9.5	19.0	0.55	±3	M2.9-M6.4	M2.6-M5.4
CL60	1400	0.7-5.0	820	245	39	78	8.0	9.5	19.0	0.55	±3	M4.1-M7.0	M3.3-M6.0
CL65	300	3.0-18.0	830	245	39	78	8.0	9.5	21.2	0.60	±3	M5.7-M9.5	M4.4-M7.5



Push Start

Full-auto shut off air

- do pracy wielozmianowej
- ekonomiczne zużycie energii
- obroty L-R

Kolorowe oznakowanie momentu

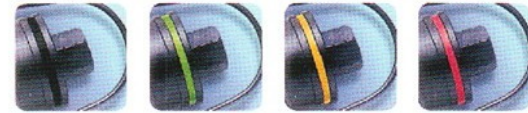

Model	Obroty (obr/min)	Zakres regulacji momentu (Nm)	Masa (g)	Długość (mm)	Średnica	Ciśnienie Kg/cm ²	Średnica węży zasilającego mm	Zużycie powietrza m/min	Odchylenie standardowe (%)	Średnica wkrętu	
										Do otworów samogwintujących	Do otworów gwintowanych
VP10	1000	0.05-0.2	430	180	29	6.0	5.0	0.25	±3	M1.0-M2.2	M1.1-M1.7
VP20	1000	0.1-1.0	430	180	29	6.0	5.0	0.25	±3	M1.7-M3.3	M1.3-M2.7
VP30	1900	0.2-2.0	430	180	29	6.0	5.0	0.25	±3	M2.2-M4.2	M1.7-M3.5
VP35	2200	0.3-2.0	430	180	29	6.0	5.0	0.25	±3	M2.4-M4.2	M2.0-M3.5
VP40	1000	0.4-3.3	430	180	29	6.0	5.0	0.25	±3	M2.3-M5.2	M2.2-M4.2
VP45	800	0.8-4.0	430	180	29	6.0	5.0	0.25	±3	M3.2-M5.7	M2.7-M4.4
VP48	1800	0.7-5.0	770	215	37	6.0	8.0	0.5	±3	M2.9-M5.8	M2.6-M4.7
VP50	1400	0.7-6.0	770	215	37	6.0	8.0	0.5	±3	M2.9-M6.0	M2.6-M4.9
VP55	1000	1.0-7.0	770	215	37	6.0	8.0	0.5	±3	M3.3-M6.4	M2.7-M5.4
VP60	550	1.5-10.0	770	215	37	6.0	8.0	0.5	±3	M4.1-M7.2	M3.3-M6.2
VP65	300	3.0-18.0	790	215	37	6.0	8.0	0.5	±3	M5.0-M9.3	M4.0-M7.2



Lever Start

Shut off air

- uruchamiana dźwignią
- ekonomiczne zużycie energii
- obroty L-R

Kolorowe oznakowanie momentu

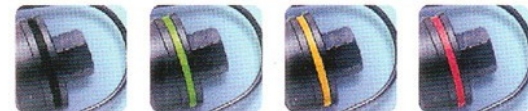

Model	Obroty (obr/min)	Zakres regulacji momentu (Nm)	Masa (g)	Długość (mm)	Średnica	Ciśnienie Kg/cm ²	Średnica węży zasilającego mm	Zużycie powietrza m/min	Odchylenie standardowe (%)	Średnica wkrętu	
										Do otworów samogwintujących	Do otworów gwintowanych
VL10	1000	0.05-0.2	520	210	29	6.0	5.0	0.25	±3	M1.0-M2.2	M1.1-M1.7
VL20	1000	0.1-1.0	520	210	29	6.0	5.0	0.25	±3	M1.7-M3.3	M1.3-M2.7
VL30	1900	0.2-2.0	520	210	29	6.0	5.0	0.25	±3	M2.2-M4.5	M1.7-M3.5
VL35	2200	0.3-2.0	520	210	29	6.0	5.0	0.25	±3	M2.4-M4.2	M2.0-M3.5
VL40	1000	0.4-3.3	520	210	29	6.0	5.0	0.25	±3	M2.3-M5.2	M2.2-M4.2
VL45	800	0.8-4.0	520	210	29	6.0	5.0	0.25	±3	M3.2-M5.7	M2.7-M4.4
VL48	1800	0.7-5.0	820	245	37	6.0	8.0	0.5	±3	M2.9-M5.8	M2.6-M4.7
VL50	1400	0.7-6.0	820	245	37	6.0	8.0	0.5	±3	M2.9-M6.0	M2.6-M4.9
VL55	1000	1.0-7.0	820	245	37	6.0	8.0	0.5	±3	M3.3-M6.4	M2.7-M5.4
VL60	550	1.5-10.0	820	245	37	6.0	8.0	0.5	±3	M4.1-M7.2	M3.3-M6.2
VL65	300	3.0-18.0	840	245	37	6.0	8.0	0.5	±3	M5.0-M9.3	M4.0-M7.2

Lever Start Angle Type

Shut off air

- kompozytowa obudowa
- uruchamiane dźwignią
- do pracy wielozmianowej
- obroty L-R

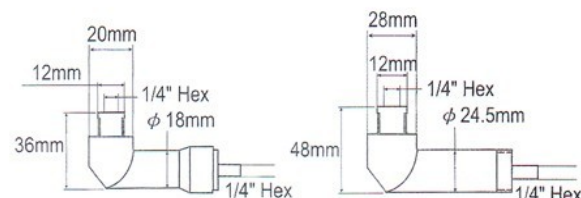

Model	Obroty (obr/min)	Zakres regulacji momentu (Nm)	Masa (g)	Długość (mm)	Średnica	Poziom hałasu (dB)	Minimalna średnica węża przy ciśnieniu		Zużycie powietrza		Odchylenie standardowe (%)	Średnica wkrętu	
							6 kg/cm ³	5 kg/cm ³	cfm	m ³ /min		Do otworów samogwintujących	Do otworów gwintowanych
CA10	1000	0.05-0.2	690	270	31	70	5.0	6.35	7.0	0.20	±3	M1.0-M2.2	M1.1-M1.7
CA20	1000	0.1-0.8	690	270	31	70	5.0	6.35	7.0	0.20	±3	M1.7-M3.3	M1.3-M2.7
CA30	1800	0.3-1.7	690	270	31	74	5.0	6.35	10.0	0.28	±3	M2.2-M4.2	M1.7-M3.2
CA35	2200	0.3-2.0	690	270	31	74	5.0	6.35	10.0	0.28	±3	M2.4-M4.5	M2.0-M3.5
CA40	1000	0.5-3.0	690	270	31	74	5.0	6.35	10.0	0.28	±3	M2.8-M5.0	M2.3-M4.0
CA45	800	0.8-4.0	690	270	31	78	6.35	8.0	10.6	0.30	±3	M3.0-M5.7	M2.7-M4.4
CA48	1800	0.5-4.5	1300	335	39	78	8.0	9.5	19.0	0.55	±3	M2.8-M5.8	M2.3-M4.7
CA50	1400	0.7-5.0	1300	335	39	78	8.0	9.5	19.0	0.55	±3	M2.9-M6.0	M2.6-M4.9
CA55	1000	0.7-6.5	1300	335	39	78	8.0	9.5	19.0	0.55	±3	M2.9-M6.4	M2.6-M5.4
CA60	550	1.5-9.5	1300	335	39	78	8.0	9.5	19.0	0.55	±3	M4.1-M7.0	M3.3-M6.0
CA65	300	3.0-18.0	1310	335	39	78	8.0	9.5	21.2	0.60	±3	M5.7-M9.5	M4.4-M7.5

Lever Start Angle Type

Full-auto Shut off air

- uruchamiana dźwignią
- do pracy wielozmianowej
- ekonomiczna
- obroty L-R

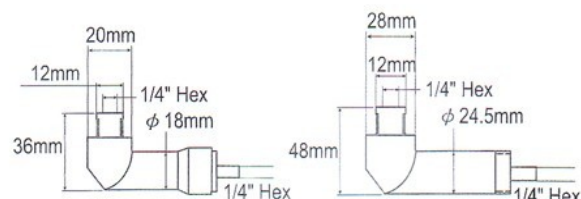

Model	Obroty (obr/min)	Zakres regulacji momentu (Nm)	Masa (g)	Długość (mm)	Średnica	Ciśnienie	Średnica węża zasilającego	Zużycie powietrza	Odchylenie standardowe (%)	Średnica wkrętu	
						Kg/cm ²				mm	m ³ /min
VA20	1000	0.1-1.0	660	270	29	6.0	5.0	0.25	±3	M1.7-M3.3	M1.3-M2.7
VA30	1900	0.2-2.0	660	270	29	6.0	5.0	0.25	±3	M2.2-M4.5	M1.7-M3.5
VA35	2200	0.3-2.0	660	270	29	6.0	5.0	0.25	±3	M2.4-M4.2	M2.0-M3.5
VA40	1000	0.4-3.3	660	270	29	6.0	5.0	0.25	±3	M2.3-M5.2	M2.2-M4.2
VA45	800	0.8-4.0	660	270	29	6.0	5.0	0.25	±3	M3.2-M5.7	M2.7-M4.4
VA48	1800	0.7-5.0	1200	345	37	6.0	8.0	0.5	±3	M2.9-M5.8	M2.6-M4.7
VA50	1400	0.7-6.0	1200	345	37	6.0	8.0	0.5	±3	M2.9-M6.0	M2.6-M4.9
VA55	1000	1.0-7.0	1200	345	37	6.0	8.0	0.5	±3	M3.3-M6.4	M2.7-M5.4
VA60	550	1.5-10.0	1200	345	37	6.0	8.0	0.5	±3	M4.1-M7.2	M3.3-M6.2
VA65	300	3.0-18.0	1400	345	37	6.0	8.0	0.5	±3	M5.0-M9.3	M4.0-M7.2

Push start or Push & Triger start shut off

- kompozytowa obudowa
- do pracy wielozmianowej
- zew. regulacja sprzęgła
- obroty L-R



CPP35
Kompaktowa obudowa
CPP38
CPP41
CPP47



CPP48
Standardowa obudowa
CPP50
CPP55
CPP60
CPP65

Model	Uchwyt	Obroty (obr/min)	Zakres regulacji momentu (Nm)	Masa (g)	Wymiary (∅ x L x H)	Ciśnienie (Kg/cm ²)	Poziom hałasu (+2dB)	Średnica węży zasilającego mm	Zużycie powietrza		Odchylenie standardowe (%)	Średnica wkrętu	
									cfm	m ³ /min		Do otworów samogwintujących	Do otworów gwintowanych
CPP35	∅ F1/4"	2200	0.3-2.0	640	33 x 178 x 160	6.0	72	5.0	10.0	0.28	+3	M2.4-M4.5	M2.0-M3.5
CPP38	∅ F1/4"	1800	0.3-2.5	640	33 x 178 x 160	6.0	72	5.0	10.0	0.28	+3	M2.4-M4.7	M2.0-M3.8
CPP41	∅ F1/4"	1000	0.5-3.5	640	33 x 178 x 160	6.0	72	5.0	10.0	0.28	+3	M2.8-M5.2	M2.2-M4.2
CPP47	∅ F1/4"	550	1.0-5.0	740	33 x 178 x 160	6.0	72	5.0	10.0	0.28	+3	M3.6-M6.0	M2.8-M4.7
CPP48	∅ F1/4"	1800	0.7-5.0	950	39 x 210 x 170	6.0	76	8.0	19.0	0.55	+3	M2.8-M6.0	M2.3-M4.9
CPP50	∅ F1/4"	1400	1.0-6.0	950	39 x 210 x 170	6.0	76	8.0	19.0	0.55	+3	M2.9-M6.2	M2.6-M5.1
CPP55	∅ F1/4"	1000	1.2-7.5	950	39 x 210 x 170	6.0	76	8.0	19.0	0.55	+3	M3.5-M6.6	M2.3-M5.6
CPP60	∅ F1/4"	550	3.0-11.0	950	39 x 210 x 170	6.0	76	8.0	19.0	0.55	+3	M5.0-M7.3	M3.3-M6.2
CPP65	∅ F1/4"	300	3.0-18.0	1100	39 x 210 x 170	6.0	76	8.0	19.0	0.55	+3	M5.0-M9.3	M3.3-M7.2

Trigger start-shut off

- kompozytowa obudowa
- do pracy wielozmianowej
- zew. regulacja sprzęgła
- obroty L-R



CBP35
Obudowa kompaktowa
CBP38
CBP41
CBP47



CBP48
Standardowa obudowa
CBP50
CBP55
CBP60
CBP65

Model	Uchwyt	Obroty (obr/min)	Zakres regulacji momentu (Nm)	Masa (g)	Wymiary (∅ x L x H)	Ciśnienie (Kg/cm ²)	Poziom hałasu (+2dB)	Średnica węży zasilającego mm	Zużycie powietrza		Odchylenie standardowe (%)	Średnica wkrętu	
									cfm	m ³ /min		Do otworów samogwintujących	Do otworów gwintowanych
CBP35	∅ F1/4"	2200	0.3-2.0	640	33 x 178 x 160	6.0	72	5.0	10.0	0.28	+3	M2.4-M4.5	M2.0-M3.5
CBP38	∅ F1/4"	1800	0.3-2.5	640	33 x 178 x 160	6.0	72	5.0	10.0	0.28	+3	M2.4-M4.7	M2.0-M3.8
CBP41	∅ F1/4"	1000	0.5-3.5	640	33 x 178 x 160	6.0	72	5.0	10.0	0.28	+3	M2.8-M5.2	M2.2-M4.2
CBP47	∅ F1/4"	550	1.0-5.0	740	33 x 178 x 160	6.0	72	5.0	10.0	0.28	+3	M3.6-M6.0	M2.8-M4.7
CBP48	∅ F1/4"	1800	0.7-5.0	950	39 x 210 x 170	6.0	76	8.0	19.0	0.55	+3	M2.8-M6.0	M2.3-M4.9
CBP50	∅ F1/4"	1400	1.0-6.0	950	39 x 210 x 170	6.0	76	8.0	19.0	0.55	+3	M2.9-M6.2	M2.6-M5.1
CBP55	∅ F1/4"	1000	1.2-7.5	950	39 x 210 x 170	6.0	76	8.0	19.0	0.55	+3	M3.5-M6.6	M2.3-M5.6
CBP60	∅ F1/4"	550	3.0-11.0	950	39 x 210 x 170	6.0	76	8.0	19.0	0.55	+3	M5.0-M7.3	M3.3-M6.2
CBP65	∅ F1/4"	300	3.0-18.0	1100	39 x 210 x 170	6.0	76	8.0	19.0	0.55	+3	M5.0-M9.3	M3.3-M7.2

Trigger start-shut off

- kompozytowa obudowa
- do pracy wielozmianowej
- zew. regulacja sprzęgła
- obroty L-R



Model	Uchwyt	Obroty (obr/min)	Zakres regulacji momentu (Nm)	Masa (g)	Wymiary (∅ x L x H)	Ciśnienie (Kg/cm ²)	Poziom hałasu (±2dB)	Średnica węży zasilającego mm	Zużycie powietrza		Odchylenie standardowe (%)	Średnica wkrętu	
									cfm	m ³ /min		Do otworów samogwintujących	Do otworów gwintowanych
CWP35	1/4"	2200	0.3-2.0	640	33 x 178 x 160	6.0	72	5.0	10.0	0.28	±3	M2.4-M4.5	M2.0-M3.5
CWP38	1/4"	1800	0.3-2.5	640	33 x 178 x 160	6.0	72	5.0	10.0	0.28	±3	M2.4-M4.7	M2.0-M3.8
CWP41	1/4"	1000	0.5-3.5	640	33 x 178 x 160	6.0	72	5.0	10.0	0.28	±3	M2.8-M5.2	M2.2-M4.2
CWP47	1/4"	550	1.0-5.0	740	33 x 178 x 160	6.0	72	5.0	10.0	0.28	±3	M3.6-M6.0	M2.8-M4.7
CWP48	3/8"	1800	0.7-5.0	950	39 x 210 x 170	6.0	76	8.0	19.0	0.55	±3	M2.8-M6.0	M2.3-M4.9
CWP50	3/8"	1400	1.0-6.0	950	39 x 210 x 170	6.0	76	8.0	19.0	0.55	±3	M2.9-M6.2	M2.6-M5.1
CWP55	3/8"	1000	1.2-7.5	950	39 x 210 x 170	6.0	76	8.0	19.0	0.55	±3	M3.5-M6.6	M2.3-M5.6
CWP60	3/8"	550	3.0-11.0	950	39 x 210 x 170	6.0	76	8.0	19.0	0.55	±3	M5.0-M7.3	M3.3-M6.2
CWP65	3/8"	300	3.0-18.0	1100	39 x 210 x 170	6.0	76	8.0	19.0	0.55	±3	M5.0-M9.3	M3.3-M7.2

Push start-shut off

- kompozytowa obudowa
- do pracy wielozmianowej
- zew. regulacja sprzęgła
- obroty L-R



Model	Uchwyt	Obroty (obr/min)	Zakres regulacji momentu (Nm)	Masa (g)	Wymiary (∅ x L x H)	Ciśnienie (Kg/cm ²)	Poziom hałasu (±2dB)	Średnica węży zasilającego mm	Zużycie powietrza		Odchylenie standardowe (%)	Średnica wkrętu	
									cfm	m ³ /min		Do otworów samogwintujących	Do otworów gwintowanych
CSP35	○F1/4"	2200	0.3-2.0	640	33 x 178 x 160	6.0	72	5.0	10.0	0.28	±3	M2.4-M4.5	M2.0-M3.5
CSP38	○F1/4"	1800	0.3-2.5	640	33 x 178 x 160	6.0	72	5.0	10.0	0.28	±3	M2.4-M4.7	M2.0-M3.8
CSP41	○F1/4"	1000	0.5-3.5	640	33 x 178 x 160	6.0	72	5.0	10.0	0.28	±3	M2.8-M5.2	M2.2-M4.2
CSP47	○F1/4"	550	1.0-5.0	740	33 x 178 x 160	6.0	72	5.0	10.0	0.28	±3	M3.6-M6.0	M2.8-M4.7
CSP48	○F1/4"	1800	0.7-5.0	950	39 x 210 x 170	6.0	76	8.0	19.0	0.55	±3	M2.8-M6.0	M2.3-M4.9
CSP50	○F1/4"	1400	1.0-6.0	950	39 x 210 x 170	6.0	76	8.0	19.0	0.55	±3	M2.9-M6.2	M2.6-M5.1
CSP55	○F1/4"	1000	1.2-7.5	950	39 x 210 x 170	6.0	76	8.0	19.0	0.55	±3	M3.5-M6.6	M2.3-M5.6
CSP60	○F1/4"	550	3.0-11.0	950	39 x 210 x 170	6.0	76	8.0	19.0	0.55	±3	M5.0-M7.3	M3.3-M6.2
CSP65	○F1/4"	300	3.0-18.0	1100	39 x 210 x 170	6.0	76	8.0	19.0	0.55	±3	M5.0-M9.3	M3.3-M7.2

- aluminiowa obudowa
- do pracy wielozmianowej
- zew. regulacja sprzęgła
- obroty L-R



Kompaktowa obudowa

APP35
APP38
APP41
APP47



Push or Push and Triger to start-shut off



Standardowa obudowa

APP48
APP50
APP55
APP60
APP65
APP68

Model	Uchwyt	Obroty (obr/min)	Zakres regulacji momentu (Nm)	Masa (g)	Wymiary (∅ x L x H)	Ciśnienie (Kg/cm ²)	Poziom hałasu (±2dB)	Średnica węża zasilającego mm	Zużycie powietrza m ³ /min	Odchylenie standardowe (%)	Średnica wkrętu	
											Do otworów samogwintujących	Do otworów gwintowanych
APP35	∅ F1/4"	2200	0.3-2.0	700	33 x 205 x 140	6.0	72	5.0	0.28	±3	M2.2-M4.5	M1.7-M3.5
APP38	∅ F1/4"	1800	0.3-2.5	700	33 x 205 x 140	6.0	72	5.0	0.28	±3	M2.2-M4.7	M1.7-M3.8
APP41	∅ F1/4"	1000	0.5-3.5	700	33 x 205 x 140	6.0	72	5.0	0.28	±3	M2.8-M5.2	M2.2-M4.2
APP47	∅ F1/4"	550	1.0-5.0	800	33 x 205 x 140	6.0	72	5.0	0.28	±3	M3.6-M6.0	M2.8-M4.9
APP48	∅ F1/4"	1800	0.7-5.0	1050	39 x 240 x 154	6.0	76	9.5	0.55	±3	M2.9-M6.0	M2.6-M4.9
APP50	∅ F1/4"	1400	1.0-6.0	1050	39 x 240 x 154	6.0	76	9.5	0.55	±3	M3.6-M6.2	M2.8-M5.1
APP55	∅ F1/4"	1000	1.2-7.5	1050	39 x 240 x 154	6.0	76	9.5	0.55	±3	M3.8-M6.6	M3.0-M5.6
APP60	∅ F1/4"	550	3.0-11.0	1050	39 x 240 x 154	6.0	76	9.5	0.55	±3	M5.0-M7.3	M4.0-M6.2
APP65	∅ F1/4"	300	3.0-18.0	1320	39 x 240 x 154	6.0	76	9.5	0.55	±3	M5.0-M9.3	M4.0-M7.2
APP68	∅ F1/4"	250	5.0-28.0	1320	39 x 240 x 154	6.0	76	9.5	0.55	±3	M6.0-M11.0	M4.9-M8.7

- aluminiowa obudowa
- do pracy wielozmianowej
- zew. regulacja sprzęgła
- obroty L-R



Kompaktowa obudowa

ABP35
ABP38
ABP41
ABP47



Triger to start-shut off



Standardowa obudowa

ABP48
ABP50
ABP55
ABP60
ABP65
ABP68

Model	Uchwyt	Obroty (obr/min)	Zakres regulacji momentu (Nm)	Masa (g)	Wymiary (∅ x L x H)	Ciśnienie (Kg/cm ²)	Poziom hałasu (±2dB)	Średnica węża zasilającego mm	Zużycie powietrza m ³ /min	Odchylenie standardowe (%)	Średnica wkrętu	
											Do otworów samogwintujących	Do otworów gwintowanych
ABP35	∅ F1/4"	2200	0.3-2.0	700	33 x 205 x 140	6.0	67	5.0	0.28	±3	M2.2-M4.5	M1.7-M3.5
ABP38	∅ F1/4"	1800	0.3-2.5	700	33 x 205 x 140	6.0	67	5.0	0.28	±3	M2.2-M4.7	M1.7-M3.8
ABP41	∅ F1/4"	1000	0.5-3.5	700	33 x 205 x 140	6.0	67	5.0	0.28	±3	M2.8-M5.2	M2.2-M4.2
ABP47	∅ F1/4"	550	1.0-5.0	800	33 x 205 x 140	6.0	67	5.0	0.28	±3	M3.6-M6.0	M2.8-M4.9
ABP48	∅ F1/4"	1800	0.7-5.0	1050	39 x 240 x 154	6.0	72	9.5	0.55	±3	M2.9-M6.0	M2.6-M4.9
ABP50	∅ F1/4"	1400	1.0-6.0	1050	39 x 240 x 154	6.0	72	9.5	0.55	±3	M3.6-M6.2	M2.8-M5.1
ABP55	∅ F1/4"	1000	1.2-7.5	1050	39 x 240 x 154	6.0	72	9.5	0.55	±3	M3.8-M6.6	M3.0-M5.6
ABP60	∅ F1/4"	550	3.0-11.0	1050	39 x 240 x 154	6.0	72	9.5	0.55	±3	M5.0-M7.3	M4.0-M6.2
ABP65	∅ F1/4"	300	3.0-18.0	1320	39 x 240 x 154	6.0	72	9.5	0.55	±3	M5.0-M9.3	M4.0-M7.2
ABP68	∅ F1/4"	250	5.0-28.0	1320	39 x 240 x 154	6.0	72	9.5	0.55	±3	M6.0-M11.0	M4.9-M8.7

- kompozytowa obudowa
- zew. reg. sprzęgła
- obroty L-R



Kompaktowa obudowa CCP39
CCP45



Standardowa obudowa CCP48
CCP58

Model	Uchwyt	Rodzaj wkrętów (mm)	Zakres regulacji momentu (Nm)	Obroty (obr/min)	Wymiary (∅ x L x H)	Zużycie powietrza		Masa (g)	Poziom hałasu (-2dB)	Minimalna średnica węża
						cfm	m³/min			
CCP39	○F1/4"	2.5 - 5.0	0.5 - 4.0	1600	36 x 140 x 142	10.0	0.28	600	72	6.35 mm
CCP45	○F1/4"	3.0 - 6.0	0.5 - 6.0	750	36 x 140 x 142	10.0	0.28	600	72	6.35 mm
CCP48	○F1/4"	3.0 - 6.0	1.0 - 6.0	1700	43 x 165 x 154	19.0	0.55	850	76	8.00 mm
CCP58	○F1/4"	3.0 - 7.0	1.0 - 9.0	750	43 x 165 x 154	19.0	0.55	850	76	8.00 mm

- kompozytowa obudowa
- napęd bezpośredni
- brak sprzęgła
- obroty L-R



Kompaktowa obudowa CDP39



Standardowa obudowa CDP48
CDP58

Model	Uchwyt	Rodzaj wkrętów (mm)	Max moment (Nm)	Obroty (obr/min)	Wymiary (∅ x L x H)	Zużycie powietrza		Masa (g)	Poziom hałasu (-2dB)	Minimalna średnica węża
						cfm	m³/min			
CDP39	○F1/4"	3.0 - 5.0	5.0	1600	36 x 140 x 142	19.0	0.55	500	72	5 mm
CDP48	○F1/4"	3.0 - 6.0	7.0	1700	45 x 159 x 154	19.0	0.55	730	76	8 mm
CDP58	○F1/4"	3.0 - 7.0	13.0	750	45 x 159 x 154	19.0	0.55	730	76	8 mm

- kompozytowa obudowa
- napęd bezpośredni
- brak sprzęgła
- obroty L-R



CPS48
CPS58

Model	Uchwyt	Rodzaj wkrętów (mm)	Max moment (Nm)	Obroty (obr/min)	Wymiar L x H (mm)		Zużycie powietrza		Masa (g)	Poziom hałasu (-2dB)	Minimalna średnica węża
							cfm	m³/min			
CPS48	○F1/4"	3.0 - 6.0	7.0	1700	159	154	19.0	0.55	790	76	8 mm
CPS58	○F1/4"	3.0 - 7.0	13.0	750	159	154	19.0	0.55	790	76	8 mm

- aluminiowa obudowa
- zew. reg. sprzęgła
- obr. L-R



Kompaktowa obudowa
ACP39
ACP45



Standardowa obudowa
ACP48
ACP58

Model	Uchwyt	Rozmiar wkrętów (mm)	Zakres regulacji momentu (Nm)	Obroty (obr/min)	Wymiary (∅ x L x H)	Zużycie powietrza		Masa (g)	Poziom hałasu (±2dB)	Minimalna średnica węża
						cfm	m ³ /min			
ACP39	○F1/4"	2.5 - 5.0	0.5 - 4.0	1600	36 x 140 x 142	10.0	0.28	600	72	6.50 mm
ACP45	○F1/4"	2.5 - 6.0	0.5 - 6.0	750	36 x 140 x 142	10.0	0.28	600	72	6.50 mm
ACP48	○F1/4"	3.0 - 6.0	1.0 - 6.0	1700	43 x 165 x 154	19.0	0.55	870	76	8.00 mm
ACP58	○F1/4"	3.0 - 7.0	1.0 - 9.0	750	43 x 165 x 154	19.0	0.55	870	76	8.00 mm

- aluminiowa obudowa
- bez sprzęgła
- obroty L-R



Kompaktowa obudowa
ADP39



Standardowa obudowa
ADP48
ADP58

Model	Uchwyt	Rozmiar wkrętów (mm)	Max moment (N-m)	Obroty (obr/min)	Wymiary (∅ x L x H)	Zużycie powietrza		Masa (g)	Poziom hałasu (±2dB)	Minimalna średnica węża
						cfm	m ³ /min			
ADP39	○F1/4"	3.0 - 5.0	4.0	1600	36 x 140 x 142	10.0	0.28	500	72	5.00 mm
ADP48	○F1/4"	3.0 - 6.0	6.0	1700	45 x 159 x 154	19.0	0.55	730	76	8.00 mm
ADP58	○F1/4"	3.0 - 7.0	13.0	750	45 x 159 x 154	19.0	0.55	730	76	8.00 mm



APS39
APS48
APS58

- aluminiowa obudowa
- bezpośredni napęd
- obroty L-R
- brak sprzęgła

Model	Uchwyt	Max moment (Nm)	Obroty (obr/min)	Wymiary (L x H)	Zużycie powietrza		Masa (g)	Poziom hałasu (±2dB)	Minimalna średnica węża
					cfm	m ³ /min			
APS39	○F1/4"	5.0	1600	160 X 142	10.0	0.28	550	72	6.35 mm
APS48	○F1/4"	7.0	1700	180 X 154	19.0	0.55	780	76	8.00 mm
APS58	○F1/4"	13.0	750	180 X 154	19.0	0.55	780	76	8.00 mm

Wiertarko - wkrętarko - gwinciarki

- kompozytowa obudowa
- obroty L-R
- zew. regulacja momentu



Kompaktowa obudowa HCD39



Standardowa obudowa HCD48
HCD58
HCD458



Wkręcanie



Wiercenie



Gwintowanie

Model	Uchwyt		Rozmiar wkrętów (mm)	Zakres regulacji momentu N-m	Obroty (obr/min)	Wymiary (∅ x L x H) (mm)	Zużycie powietrza		Masa (g)	Poziom hałasu (-2dB)	Minimalna średnica węża
	mm	inch					cfm	m ³ /min			
HCD39	6	1/4	2.5 - 5.0	0.5 - 4.0	1600	36 x 195 x 160	10.0	0.28	700	72	6.35 mm
HCD48	10	3/8	3.0 - 6.0	1.0 - 6.0	1700	45 x 215 x 160	19.0	0.55	1095	76	8.00 mm
HCD58	10	3/8	3.0 - 7.0	1.0 - 9.0	750	45 x 215 x 160	19.0	0.55	1095	76	8.00 mm
HCD458	13	1/2	3.0 - 7.0	1.0 - 9.0	750	45 x 235 x 160	19.0	0.55	1220	76	8.00 mm

Wiertarki

- kompozytowa obudowa
- bezpośredni napęd
- obroty L-R



Kompaktowa obudowa HDD26



Standardowa obudowa HDD48
HDD58
HDD458



kompaktowa obudowa HDD39

Model	Uchwyt		Rozmiar wkrętów (mm)	Max moment N-m	Obroty (obr/min)	Wymiary (∅ x L x H)	Zużycie powietrza		Masa (g)	Poziom hałasu (-2dB)	Minimalna średnica węża
	mm	inch					cfm	m ³ /min			
HDD26	6	1/4	3.0 - 5.0	3.5	2900	36 x 140 x 142	10.0	0.28	580	72	5 mm
HDD39	10	3/8	3.0 - 5.0	5.0	1600	36 x 140 x 142	10.0	0.28	580	72	5 mm
HDD48	10	3/8	3.0 - 6.0	7.0	1700	45 x 159 x 154	19.0	0.55	920	76	8 mm
HDD58	10	3/8	3.0 - 6.0	13.0	750	45 x 159 x 154	19.0	0.55	920	76	8 mm
HDD458	13	1/2	3.0 - 6.0	13.0	750	45 x 159 x 154	19.0	0.55	920	76	8 mm

Wiertarko - wkrętarko - gwinciarki

- aluminiowa obudowa
- obroty L-P



Wkręcanie



Wiercenie



Gwintowanie

 Kompaktowa obudowa **ACD39**

 Standardowa obudowa **ACD48**
ACD58

Model	Uchwyt (mm)	Rozmiar wkrętów (mm)	Zakres regulacji momentu (N-m)	Obroty (obr/min)	Wymiary (∅ x L x H)	Zużycie powietrza		Masa (g)	Poziom hałasu (±2dB)	Minimalna średnica węża
						cfm	m ³ /min			
ACD39	6.0	2.5 - 5.0	0.5-4.0	1600	36 x 165 x 142	10.0	0.28	700	72	6.50 mm
ACD48	10.0	1.0 - 6.0	1.0-6.0	1700	43 x 214 x 154	19.0	0.55	1050	76	8.00 mm
ACD58	10.0	1.0 - 7.0	1.0-9.0	750	43 x 214 x 154	19.0	0.55	1050	76	8.00 mm

Wiertarki

 Kompaktowa obudowa **ADD26**

ADD48
Standard Body **ADD58**
ADD458

 Kompaktowa obudowa **ADD39**

- aluminiowa obudowa
- bezpośredni napęd
- obroty L-R
- brak sprzęgła

Model	Wiertło (mm)	Obroty (obr/min)	Wymiary (∅ x L x H)	Zużycie powietrza		Masa (g)	Poziom hałasu (±2dB)	Minimalna średnica węża
				cfm	m ³ /min			
ADD26	6	2900	36 x 140 x 142	10.0	0.28	600	72	5.00 mm
ADD39	10	1600	36 x 140 x 142	10.0	0.28	600	72	5.00 mm
ADD48	10	1700	43 x 159 x 154	19.0	0.55	850	76	8.00 mm
ADD58	10	750	43 x 159 x 154	19.0	0.55	850	76	8.00 mm
ADD458	13	750	43 x 159 x 154	19.0	0.55	850	76	8.00 mm

Wkrętki pneumatyczne proste

- kompozytowa obudowa
- zew. regulacja momentu
- obroty L-R



CS39
CS45
Kompaktowa obudowa



CS48
CS58
Standardowa obudowa

Model	Uchwyt	Rodzaj wkrętów (mm)	Zakres regulacji momentu (Nm)	Obroty (obr/min)	Wymiary (L x H)	Zużycie powietrza		Masa (g)	Poziom hałasu (-2dB)	Minimalna średnica węża
						cfm	m ³ /min			
CS39	○F1/4"	3.0 - 6.0	0.5 - 4.0	1600	35 x 140	10.0	0.28	600	72	6.35 mm
CS45	○F1/4"	3.0 - 7.0	0.5 - 6.0	750	35 x 140	10.0	0.28	600	72	6.35 mm
CS48	○F1/4"	2.5 - 5.0	0.6 - 6.0	1700	43 x 206	19.0	0.55	842	76	8.00 mm
CS58	○F1/4"	5.7 - 7.0	0.6 - 9.0	750	43 x 206	19.0	0.55	842	76	8.00 mm

Wiertarko - wkrętko - gwinciarzki

- kompozytowa obudowa
- automatyczny uchwyt
- obroty L-R



Wkręcanie



Wiercenie



Gwintowanie



CD48
CD58

Model	Uchwyt		Rodzaj wkrętów (mm)	Zakres regulacji momentu (Nm)	Obroty (obr/min)	Wymiary (L x H)	Zużycie powietrza		Masa (g)	Poziom hałasu (-2dB)	Minimalna średnica węża
	mm	inch					cfm	m ³ /min			
CD48	10.0	3/8	3.0 - 6.0	0.6 - 6.0	1700	43 x 258	19.0	0.55	1022	76	8 mm
CD58	10.0	3/8	3.0 - 7.0	0.6 - 9.0	750	43 x 258	19.0	0.55	1022	76	8 mm

Klucze impulsowe



IPW-300
IPW-310
IPW-320



IPW-300A

Wkrętarki impulsowe



IPS-200
IPS-210
IPS-230



IPS-210



IPS-220
IPS-230

Model	Uchwyt	Wkręt	Obroty (obr/min)	Zakres regulacji momentu 0,63 Mpa (Nm)	Długość (mm)	Masa (kg)	Zużycie powietrza	Średnica węża zasilającego
	mm	mm					m ³ /min	mm
IPS-200	6.35	M3-M4	11000	3-5	220	0.72	0.16	8.0
IPS-210	6.35	M5	7500	8-15	250	0.97	0.20	8.0
IPS-220	6.35	M6-M8	7000	14-24	250	0.91	0.25	8.0
IPS-230	6.35	M8	6500	20-30	256	1.00	0.30	10.0
IPW-300	9.50	M5	7500	10-20	168	0.95	0.20	8.0
IPW-310	9.50	M6-M8	7000	16-28	250	0.90	0.25	8.0
IPW-320	9.50	M8	6500	20-35	256	0.99	0.30	8.0
IPW-300A	9.50	M8	6500	18-25	283	1.50	0.30	8.0

Wkrętaraki i klucze impulsowe shut - off



IPS-200PF



IPW-300PF



IPW-400PF
IPW-410PF
IPW-420PF
IPW-430PF

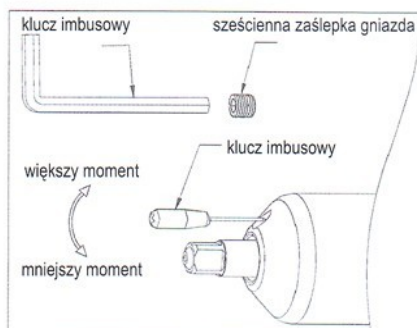

Jak zwiększyć moment obrotowy

Narzędzie najlepiej pracuje na twardych połączeniach

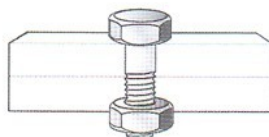

Twarde połączenie

Kiedy narzędzie pracuje z miękkim połączeniem, należy uważać by nie przekroczyło 360°. Inaczej spadnie jego wydajność. W razie takiej ewentualności należy zwiększyć rozmiar narzędzie o jeden numer.

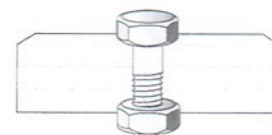

Miękkie połączenie

Model	Uchwyt	Śruba	Obroty (obr/min)	Zakres regulacji momentu 0,63 Mpa (Nm)	Długość (mm)	Masa (kg)	Zużycie powietrza	Średnica węża zasilającego
	mm						m ³ /min	
IPS-200PF	6.35	M8-M10	7400	20-28	173	1.43	0.45	10.0
IPW-300PF	9.50	M8-M10	7400	22-32	194	1.61	0.30	10.0
IPW400PF	12.70	M10-M12	5400	30-50	210	2.00	0.35	10.0
IPW410PF	12.70	M10-M12	4000	40-60	215	2.20	0.45	10.0
IPW-420PF	12.70	M12	4200	55-80	217	2.66	0.50	10.0
IPW430PF	12.70	M12-M14	2900	75-110	248	3.20	0.55	10.0

Wkrętarki i klucze impulsowe



IPS-200P



IPS-210P
IPS-220P



IPS-230P



IPW-300P
IPW-310P
IPW-320P



IPW-330P



IPW-400P
IPW-410P
IPW-420P
IPW-430P

Model	Uchwyt	Wkręt	Obroty (obr/min)	Zakres regulacji momentu 0,63 Mpa (Nm)	Długość (mm)	Masa (kg)	Zużycie powietrza	Średnica węża zasilającego
	mm	mm					m ³ /min	mm
IPS-200P	6.35	M4-M5	7500	8-15	168	1.00	0.20	8.0
IPS-210P	6.35	M5-M6	7000	14-24	166.5	0.99	0.25	8.0
IPS-220P	6.35	M6-M8	6500	20-30	166.5	1.02	0.30	8.0
IPS-230P	6.35	M8-M10	6000	25-35	175	1.47	0.45	10.0
IPW-300P	9.50	M5-M6	7500	10-20	168	1.08	0.20	8.0
IPW-310P	9.50	M5-M6	7000	16-28	167	1.00	0.30	8.0
IPW-320P	9.50	M6-M8	6500	20-35	167	1.03	0.30	8.0
IPW-330P	9.50	M8-M10	6000	30-45	173	1.42	0.45	10.0
IPW-400P	12.70	M10-M12	5800	30-55	180	1.85	0.58	10.0
IPW-410P	12.70	M10-M12	4600	40-65	186	1.98	0.58	10.0
IPW-420P	12.70	M12	5500	45-80	191	2.39	0.60	10.0
IPW-430P	12.70	M12-M14	3400	100-130	220	3.07	0.65	10.0

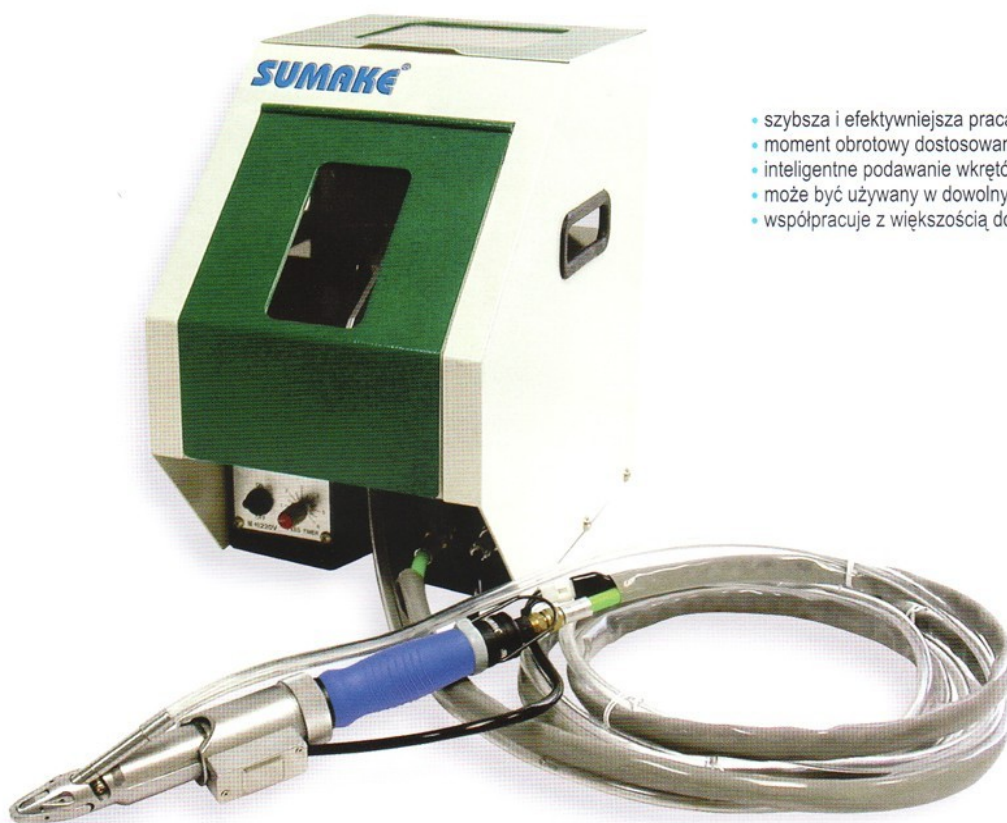

- szybsza i efektywniejsza praca
- moment obrotowy dostosowany w zależności od narzędzia
- inteligentne podawanie wkrętów - oszczędność energii
- może być używany w dowolnym miejscu
- współpracuje z większością dostępnych wkrętarek pneumatycznych

Model	Wielkość wkrętu	Długość wkrętu	Maksymalna średnica łba	Tolerancja	Wymiary dł./szer./wys.	Masa	Napięcie	Ciśnienie
SF30A-3.0	M3.0	6-22	(A) 1.5 ~ 10.5	± 0.2	35cmx25cmx38cm	22 kg	110/220V	5 kg/cm ²
SF30A-4.0	M4.4	8-25						
SF30A-5.0	M5.0	10-25						
SF30A-6.0	M6.0	12-25						

Wymiary:

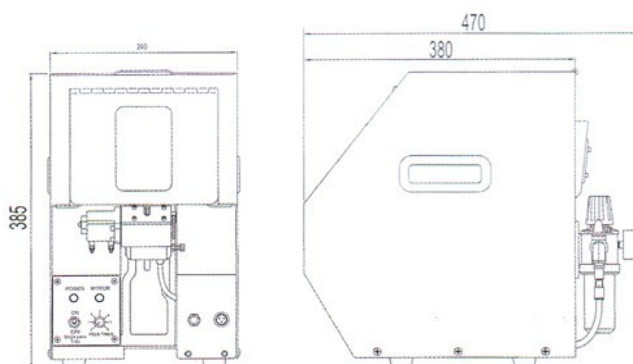
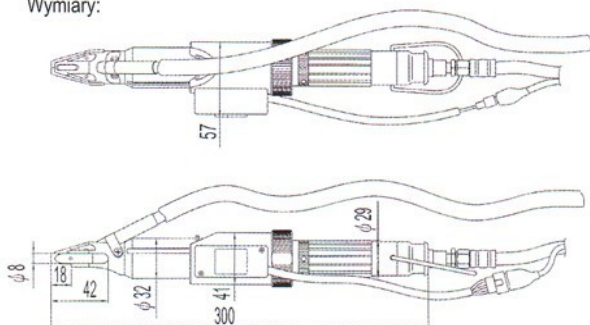

Przeznaczony do ustawiania momentu roboczego kluczy oraz wkrętarek elektrycznych i pneumatycznych ze sprzęgłem odłączającym napęd.

Parametry :

- ładowalna bateria (akumulator)
- funkcja automatycznego wyłączenia zasilania zapobiega utracie danych
- możliwość połączenia się z urządzeniem za pomocą portu szeregowego RS232
- wyzerowanie jednym dotknięciem
- wyświetlanie zmierzonej wartości,
- automatyczne czyszczenie ustawień
- funkcja oceny niskich i wysokich wartości
- możliwość sprawdzania minimum maksimum i wartości średniej



Cyfrowy miernik momentów CD-100 M

Model	CD-100M
Zakres pomiarów	0.10 - 10 N-m
	1.0 - 100 kgf - cm
	1.0 - 90 lbf - in
Dokładność	+0.5% (F/S)
Wyświetlanie	3.5 cyfrowe elektroniczne wyświetlanie LCD
Kierunek pomiaru	CW-CCW(prawo-lewo)
Funkcja oceny niskich i wysokich wartości	wartości wysokie i niskie są mierzone bez limitów i mogą być ustawiane
"Przerób" w czasie rzeczywistym	wgrana wartość momentu obrotowego jest przekazywana na port rs232 co 1/100 sekundy
Wyświetlanie wartości minimalnej, maksymalnej i średniej	oraz ostatnich 30 wartości, które są zachowywane na 10 kanałach
Automatyczne czyszczenie	automatycznie czyści wyświetlaną wartość po określonym czasie(od 0,5 - 3,0 sekund, wybieralny co 0.5 sekundy)
Wyzerowanie (jednym ruchem)	został wciśnięty przycisk wyzerowania, dane zostały wyczyszczone
Wyjście danych	zgodny z RS232C (szybkość transmisji 9600)
Zasilanie	5 baterii akumulatorowych Ni-Cd 1.2V
Zachowywanie energii	automatyczne wyłączenie zasilania po 10minutach nie używania
Czas ładowania	mniej niż 6 godzin
Czas nieprzerwanej pracy	12 godzin
Waga	1kg
Wymiary zewnętrzne	155(dł) x 125(szer) x 55(wys)
Akcesoria (po jednej sztuce każde)	zasilacz , certyfikat zgodności, raport inspekcyjny

Podpory stosuje się podczas pracy narzędziami pneumatycznymi oraz elektrycznymi.

Szczególnie przydatne do precyzyjnej pracy wkrętarekmi.

- siła podnoszenia regulowana cylindrem pneumatycznym
- zastosowanie do wkrętów pneumatycznych i elektrycznych
- wzmocniona konstrukcja
- redukcja reakcji momentu narzędzia na dłoń operatora do 11 Nm
- wykończenie z anodowanego aluminium
- konstrukcja przystosowana do szybkiego montażu na stołach

Ramiona podporowe

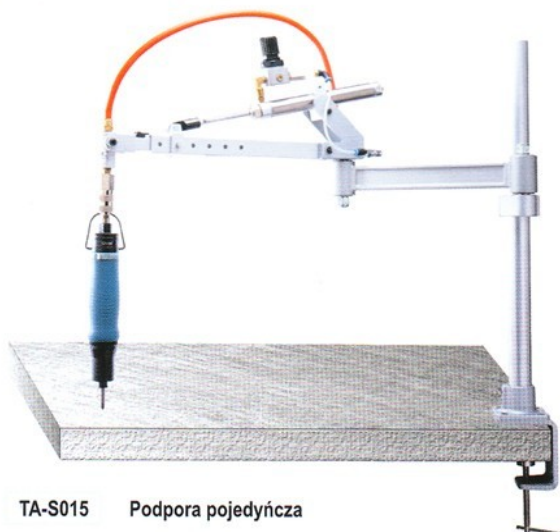

TA-S015 Podpora pojedyncza

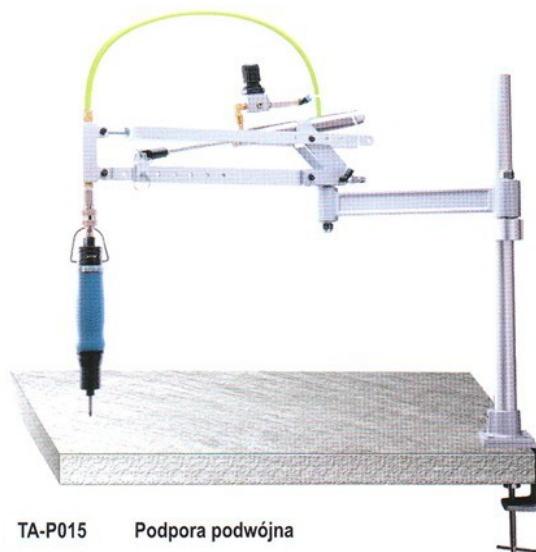

TA-P015 Podpora podwójna

Model	Zasięg (mm)	Obciążenie (kg)	Max moment (Nm)
TA-S015	10-838	0-8.8	11.2
TA-P015	10-838	0-8.8	11.2

ST-4430



- jednokierunkowa

ST-4431



- obroty L-P

ST-4431C



- obroty L-P
- automatyczny uchwyt

ST-4130



- jednokierunkowa

ST-4131



- obroty L-P

ST-4434A



- obroty L-P

ST-4433A



- jednokierunkowa

ST-4436



ST-4438



Uchwyty wiertarskie 10 mm



4431-02



4431-02C

Model	Max. średnica wiertła mm	Obroty (obr/min)	Długość (mm)	Przyłącze powietrza	Średnica węża zasilającego	Zużycie powietrza		Masa (kg)
						cfm	l/min	
ST-4430	10	1800	180	1/4"	3/8"	6.0	170	0.9
ST-4130	10	1800	180	1/4"	3/8"	6.0	170	1.1
ST-4131	10	1800	180	1/4"	3/8"	6.0	170	0.9
ST-4431C	10	1800	180	1/4"	3/8"	6.0	170	0.9
ST-4434A	10	1800	180	1/4"	3/8"	6.0	170	1.4
ST-4431	10	1800	180	1/4"	3/8"	6.0	170	0.9
ST-4433A	10	2000	165	1/4"	3/8"	6.0	170	1.13
ST-4436	10	1800	180	1/4"	3/8"	6.0	170	1.8
ST-4438	10	2600	203	1/4"	3/8"	6.0	170	0.9

ST-4440



- jednokierunkowa

ST-4441



- obroty L-P

ST-4441C



- obroty L-P
- automatyczny uchwyt

ST-4443A



- jednokierunkowa
- heavy duty

ST-4444A



- obroty L-P
- heavy duty

ST-4444AC



- obroty L-P
- automatyczny uchwyt
- heavy duty

ST-4250



- obroty L-P
- regulacja obrotów

ST-4250-6



- obroty L-P
- regulacja obrotów

Uchwyty wiertarskie 13 mm



4441-02



4441-02C

Model	Uchwyt		Obroty (obr/min)	Długość (mm)	Przyłącze powietrza	Średnica węża zasilającego	Zużycie powietrza		Masa (kg)
	inch	mm					cfm	l/min	
ST-4250	5/8	16	1000	420	3/8"	3/8"	3.0	85	6.3
ST-4250-6	3/4	19	1000	420	3/8"	3/8"	3.0	85	6.3
ST-4440	1/2	13	800	180	1/4"	3/8"	6.0	170	0.9
ST-4441	1/2	13	800	180	1/4"	3/8"	6.0	170	0.9
ST-4441C	1/2	13	800	180	1/4"	3/8"	6.0	170	0.9
ST-4443A	1/2	13	400	180	1/4"	3/8"	6.0	170	1.8
ST-4444A	1/2	13	800	190	1/4"	3/8"	6.0	170	1.8
ST-4444AC	1/2	13	800	190	1/4"	3/8"	6.0	170	1.8

ST-4480

- obroty L-P
- 5-13 Nm

ST-4481

- obroty L-P
- 5 - 16 Nm

ST-4486

- obroty L-P
- 5-13 Nm

ST-4487

- obroty L-P
- 5-16 Nm

ST-4488

- obroty L-P
- bez zew. regulacji sprzęgła
- 5-13 Nm

ST-4489

- obroty L-P
- zew. regulacja sprzęgła
- 5-16 Nm

ST-4510

- obroty L-P
- zew. regulacja sprzęgła
- 2,5 - 9 Nm

ST-4511

- obroty L-P
- zew. regulacja sprzęgła
- 2,5 - 12 Nm

ST-4450

- obroty L-P
- 1,15 - 3,45 Nm

ST-6SLD

- obroty L-P
- mechanizm udarowy
- 9,8 - 18 Nm

ST-6SSLD

- obroty L-P
- mechanizm udarowy
- 9,8 - 18 Nm

ST-6SL

- obroty L-P
- mechanizm udarowy
- 9,8 - 18 Nm

Model	Rozmiar wkrętów (mm)	Moment (Nm)	Obroty (obr/min)	Długość (mm)	Przyłącze powietrza	Średnica węży zasilającego	Zużycie powietrza	Masa (kg)
							l/min	
ST-4480	6(6.35)	5-13	1800	180	1/4"	3/8"	142	1.14
ST-4481	6	5-16	800	216	1/4"	3/8"	142	1.21
ST-4486	6	5-13	1800	180	1/4"	3/8"	113	1.14
ST-4487	6	5-16	800	216	1/4"	3/8"	113	1.21
ST-4488	6	5-13	1800	230	1/4"	3/8"	113	1.36
ST-4489	6	5-16	800	254	1/4"	3/8"	113	1.36
ST-4510	3-5	2,5-9	1800	230	1/4"	3/8"	125	1.30
ST-4511	3-5	2,5-12	800	244	1/4"	3/8"	125	1.43
ST-4450	4	1.15-3.45	1500	210	1/4"	3/8"	142	0.65
ST-6SLD	6	9.8-18	8000	175	1/4"	1/4"	300	1.13
ST-6SSLD	6	9.8-18	8000	202	1/4"	1/4"	300	1.00
ST-6SL	6	9.8-18	8000	168	1/4"	1/4"	300	1.20

ST-C504



ST-C535



ST-C540



ST-540-2



ST-C541



ST-C544



ST-C562



ST-C563

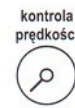

ST-C580



- klucz C 540 1/24
- nasadki 1/2" - 9,10,11,13,14,17,19,22,24,27
- mini olejarka
- przedłużka 125 mm
- aluminiowa walizka



ST-C540KB

- klucz C-562 3/4"
- nasadki 3/4" - 26,27,29,30,32,35,36,38
- mini olejarka
- aluminiowa walizka



ST-C562KB

Model	Czop (inch)	Rozmiar śrub (mm)	Obroty (obr/min)	Moment (N-m)	Długość (mm)	Przyłącze powietrza	Średnica węża zasilającego	Zużycie powietrza		Poziom hałasu (dB)	Masa (kg)
								cfm	l/min		
ST-C504	1/2	M16	10000	949	178	1/4"	3/8"	13.0	368	93	2.02
ST-C535	3/8	M14	10000	434	165	1/4"	3/8"	6.0	170	92	1.20
ST-C540	1/2	M19	7500	813	195	1/4"	3/8"	8.0	226	92	2.00
ST-540-2	1/2	M19	7500	813	225	1/4"	3/8"	8.0	226	92	2.30
ST-C541	1/2	M16	10000	542	165	1/4"	3/8"	6.0	170	92	1.20
ST-C544	1/2	M13	10000	434	170	1/4"	3/8"	10.6	300	92	1.20
ST-C562	3/4	M25	4000	1491	240	3/8"	3/8"	12.00	340	92	3.80
ST-C563	3/4	M28	5500	1355	211	3/8"	1/2"	14.00	396	96	3.50
ST-C580	1	M41	5300	1626	256	3/8"	1/2"	15.80	447	98	5.10



Model	Uchwyt (inch)	Wkręt (mm)	Obroty (obr/min)	Moment (N-m)	Długość (mm)	Przyłącze powietrza	Średnica węża zasilającego	Zużycie powietrza		Masa (kg)
								cfm	l/min	
ST-M3006	1/2	M14	6500	407	187	1/4"	3/8"	5.6	158	2.2
ST-M3007	1/2	M19	6500	542	180	1/4"	3/8"	5.6	226	2.1
ST-5544H	1/2	M16	7000	542	184	1/4"	3/8"	8.0	226	2.7
ST-5548	1/2	M19	6500	813	200	1/4"	3/8"	8.0	226	2.8
ST-6667	3/4	M38	5000	1553	216	3/8"	1/2"	12.0	340	5.3
ST-6669	3/4	M32	4500	1350	230	1/4"	3/8"	12.0	340	5.6
ST-55882	1	M41	3500	2170	300	1/2"	1/2"	20.0	566	8.9
ST-6684L	1	M41	3500	2170	530	1/2"	1/2"	20.0	566	11.0
ST-5596	1	M32	4000	1882	335	3/8"	3/8"	6.6	187	6.2
ST-5596-6	1	M32	4000	1882	450	3/8"	3/8"	6.6	187	7.26
ST-6800	1	M50	3000	3660	443	1/2"	1/2"	23.0	651	14.2
ST-6800-8	1	M50	3000	3660	630	1/2"	1/2"	23.0	651	16.0
ST-5589	1-1/2	M50	3000	4065	450	1/2"	3/4"	23.0	651	19.7
ST-5589-L	1-1/2	M50	3000	4065	646	1/2"	3/4"	23.0	651	22.8

ST-5555
ST-5555A



ST-5556



ST-5554



ST-55522



• kompozyt

ST-55520



• kompozyt

ST-55524



• kompozyt

ST-55523



• kompozyt

ST-55521



• kompozyt

ST-55525



• kompozyt

Model	Uchwyt (inch)	Wkręt (mm)	Obroty (obr/min)	Moment (N-m)	Długość (mm)	Przyłącze powietrza	Średnica węży zasilającego	Zużycie powietrza		Masa (kg)
								cfm	l/min	
ST-5555	1/4	M7	230	41	165	1/4"	1/4"	4.0	113	0.5
ST-5555A	3/8	M7	230	41	165	1/4"	1/4"	4.0	113	0.5
ST-5556	1/2	M13	170	68	227	1/4"	3/8"	4.0	113	1.2
ST-5554	1/2	M13	150	122	254	1/4"	3/8"	5.0	142	2.0
ST-55522	1/4	M10	350	68	205	1/4"	3/8"	3.5	99	0.66
ST-55520	3/8	M10	280	108	277	1/4"	3/8"	4.0	113	1.24
ST-55524	3/8	M13	225	122	313	1/4"	3/8"	4.0	113	1.60
ST-55523	3/8	M10	350	68	205	1/4"	3/8"	3.5	99	0.66
ST-55521	1/2	M10	280	108	277	1/4"	3/8"	4.0	113	1.24
ST-55525	1/2	M13	225	122	313	1/4"	3/8"	4.0	113	1.60

Katowe

ST-7737



- wrzeciono M14x2
- moc 0,45 KW

ST-7741



- wrzeciono 5/8" x 110 NC
- moc 0,8 KW

ST-7745L



- wrzeciono M14x2
- moc 0,55 KW

ST-7747L



- wrzeciono 5/8" x 110 NC
- moc 0,95 KW

ST-7784



- wrzeciono 5/8" x 110 NC

Model	Średnica tarczy (mm)	Obroty (obr/min)	Długość (mm)	Przyłącze powietrza	Średnica węża zasilającego	Zużycie powietrza		Masa (kg)
						cfm	l/min	
ST-7737	125	11000	230	1/4"	3/8"	6.0	170	1.8
ST-7741	180	7000	343	3/8"	1/2"	9.0	257	3.2
ST-7745L	125	10900	208	1/4"	3/8"	6.0	170	1.6
ST-7747L	180	7600	254	3/8"	1/2"	9.0	257	3.1
ST-7784	230	5900	279	1/2"	3/4"	20.0	566	5.8

Trzpieniowe

ST-7780L



ST-7780



ST-7781



ST-7781L



Model	Obroty (obr/min)	Wymiar tarczy \varnothing (mm)	Wymiar szczotki size \varnothing (mm)	Wrzeciono \varnothing	Masa (kg)	Długość (mm)	Przyłącze powietrza	Średnica węża zasilającego	Zużycie powietrza (l/min)
ST-7780L	12000	75 x 9.5 x 13	75 x 12.7 x 13	3/8" - 24 UNF	2.0	430	3/8"	1/4"	170
ST-7780	12000	75 x 9.5 x 13	75 x 12.7 x 13	3/8" - 24 UNF	2.3	380	3/8"	1/4"	170
ST-7781L	5000	-	125 x 12.7 x 15	1/2" - 13 UNF	2.0	430	3/8"	1/4"	170
ST-7781	5000	-	125 x 12.7 x 15	1/2" - 13 UNF	2.3	380	3/8"	1/4"	170

ST-7732M



ST-7733M



ST-7734M



ST-7732FM



ST-7733FM



ST-7734FM



ST-M3004M



ST-M3005M



ST-M3050M



ST-7733LM



ST-M3053M



ST-38LE



heavy duty

Model	Uchwyt trzpienia (mm)	Obroty (obr/min)	Długość (mm)	Przyłącze powietrza	Średnica węża zasilającego	Zużycie powietrza		Masa (kg)
						cfm	l/min	
ST-7732(M)	6	25000	120	1/4"	3/8"	3.0	85	0.3
ST-7733(M)	6	22000	282	1/4"	3/8"	4.0	113	0.9
ST-7734(M)	6	20000	146	1/4"	3/8"	3.0	85	0.49
ST-7732(FM)	6	25000	120	1/4"	3/8"	3.0	85	0.3
ST-7733(FM)	6	20000	146	1/4"	3/8"	4.0	113	0.53
ST-7734(FM)	6	18000	124	1/4"	3/8"	3.0	85	0.4
ST-M3004(M)	6	22000	190	1/4"	3/8"	22	85	0.67
ST-M3005(M)	6	25000	170	1/4"	3/8"	3.7	105.0	0.45
ST-M3050(M)	6	20000	176	1/4"	3/8"	1.9	53.8	0.6
ST-7733(LM)	6	25000	260	1/4"	3/8"	4.0	113	0.64
ST-M3053(M)	6	23000	300	1/4"	3/8"	1.8	50.9	0.73
ST-38(LE)	6	25000	290	1/8"	1/4"	4.0	113	0.8

W ofercie również z uchwytem 8 mm

OSN-60HE



OSG-60HE



ST-7715P



ST-7718



ST-7729C



ST-7719



ST-7717



ST-7717S



ST-7709

ST-7710

ST-7710L



Model	Obroty (obr/min)	Zużycie powietrza		Moc		Ciśnienie BAR	Przyłącze powietrza	Średnica węża zasilającego	Długość (mm)	Masa (kg)	Poziom hałasu (dB)
		SCFM	l/min	HP	W						
OSN-60HE	10000	16	413	0.24	179	6.3	1/4"	1/4"	166.3	0.85	81
OSG-60HE	10000	16	413	0.24	179	6.3	1/4"	1/4"	221.1	0.94	88

Model	Wymiar stopy (mm)	Wrzeciono	Obroty (obr/min)	Długość (mm)	Przyłącze powietrza	Średnica węża zasilającego	Zużycie powietrza		Masa (kg)
							cfm	l/min	
ST-7715P	153	5/16"-24NF	9000	254	1/4"	3/8"	6	171	2.1
ST-7718	90 x 197	-	8000	203	1/4"	3/8"	6	171	1.97
ST-7729C	112 x 220	-	6000	305	1/4"	3/8"	8	228	2.2
ST-7719	70 x 444	-	2500	410	1/4"	3/8"	6	171	3.1
ST-7717	100 x 110	-	20000	127	1/4"	3/8"	5	142	0.5
ST-7717S	75 x 82	-	15000	127	1/4"	3/8"	5	142	0.5
ST-7709	10 x 330	-	16000	260	1/4"	3/8"	6	171	0.9
ST-7710	20 x 520	-	16000	340	1/4"	3/8"	6	171	1.2
ST-7710L	12.7 x 610	-	16000	470	1/4"	3/8"	6	171	1.1

Polerki

ST-7774



ST-7775



ST-7776



Polerki z płaszczem wodnym

ST-7777L



ST-77775L



ST-77773



ST-77480



ST-77494



ST-77490



Model	Wymiar stopy (mm)	Wrzeciono	Obroty (obr/min)	Długość (mm)	Przyłącze powietrza	Średnica węża zasilającego	Zużycie powietrza		Masa (kg)
							cfm	l/min	
ST-7774	180	5/8"-11	2500	406	1/4"	3/8"	6	171	2.9
ST-7775	180	5/8"-11	4500	441	1/4"	3/8"	6	171	2.9
ST-7776	180	5/8"-11	2500	453	1/4"	3/8"	6	171	2.9
ST-77772L	75 - 102	5/8"-11	4500	242	1/4"	3/8"	8	228	1.16
ST-77775L	75 - 102	5/8"-11	5000	250	1/4"	3/8"	8	228	1.27
ST-77773	127	5/8"-11	11000	260	1/4"	3/8"	8	228	2.0
ST-77480	127	-	8000	160	1/4"	3/8"	8	228	0.95
ST-77494	73x140	-	8000	170	1/4"	3/8"	8	228	0.95
ST-77490	73x98	-	8000	150	1/4"	3/8"	8	228	0.9



W ofercie również
igły \varnothing 2 ; 3 ; 4 mm / 180 mm

Model	Uderzeń /min	Wymiar igieł	Średnica węża zasilającego	Ciśnienie	Zużycie powietrza	Masa (kg)	Długość (mm)
			(PT)	(Bar)	(L/min)		
ST-2272L	7200	-	1/4"	6.2	120	1.9	480
ST-2272	7200	-	1/4"	6.2	120	1.9	480
ST-2274	2800	-	3/8"	6.2	325	3.9	496
ST-2553	3800	\varnothing 3x180x28 szt.	3/8"	6.2	250	3.5	360
ST-2554	2500	\varnothing 3x180x49 szt.	1/4"	6.2	250	5.0	400
ST-2559	3000	\varnothing 3x180x28 szt.	3/8"	6.2	250	4.5	254
ST-2275	4000	\varnothing 3x180x19 szt.	1/4"	6.2	250	2.5	410
ST-2276-3L	2200	\varnothing 3x180x28 szt.	1/4"	6.2	285	11.05	620
ST-2276-4L	2200	\varnothing 3x180x28 szt.	1/4"	6.2	285	11.05	1220
ST-2276-5L	2200	\varnothing 3x180x28 szt.	1/4"	6.2	285	11.05	1520
ST-2276-6L	2200	\varnothing 3x180x28 szt.	1/4"	6.2	285	11.05	1820
ST-2550	3700	\varnothing 3x180x19 szt.	1/4"	6.2	160	2.6	375
ST-2556	4400	\varnothing 3x180x19 szt.	1/4"	6.2	250	2.8	410
ST-2557	4400	\varnothing 3x180x19 szt.	1/4"	6.2	230	2.7	410

ST-2201H
ST-2202H



ST-2203H



ST-2204H



ST-2231H
ST-2232H



ST-2233H
ST-2234H



ST-2311H



ST-2556F



ST-2312K/H



Model	Średnica tłoka (mm)	Skok tłoka (mm)	Uderzeń /min	Długość (mm)	Przyłącze powietrza	Średnica węża zasilającego	Zużycie powietrza		Masa (kg)
							cfm	l/min	
ST-2201H	28.5	25	2820	308	3/8"	1/2"	8	228	5.5
ST-2202H	28.5	51	2400	327	3/8"	1/2"	8	228	5.9
ST-2203H	28.5	76	1920	378	3/8"	1/2"	12	342	6.5
ST-2204H	28.5	102	1500	410	3/8"	1/2"	12	342	7.0
ST-2231H	19.0	81	2500	240	1/4"	3/8"	10	283	2.4
ST-2232H	19.0	96	2100	280	1/4"	3/8"	10	283	2.6
ST-2233H	19.0	82	3000	215	1/4"	3/8"	14	395	1.6
ST-2234H	19.0	103	2200	260	1/4"	3/8"	16	452	1.9
ST-2311H	19.05	41	4500	133	1/4"	3/8"	4	113	1.12
ST-2556F	∅25.4x43.5	-	4400	330	1/4"	3/8"	10	283	2.5

Dłuta do młotków pneumatycznych

ST-2003/H Zestaw dłut krótkich (sześciokątne) 4 szt. 5"



ST-2003/R Zestaw dłut krótkich (okrągłe) 4 szt. 5"



ST-2004/H Zestaw dłut długich (sześciokątne) 5 szt. 7"



ST-2004/R Zestaw dłut długich (okrągłe) 5 szt. 7"



Dłuta do młotków ścinaków

(R: Trzpień okrągły - model ST-2556F, ST-2558F)

(S: Trzpień kwadratowy - model ST-2551, ST-2552, ST-2557F)



Dłuta do młotków pneumatycznych wyburzeniowych

Do mini młotków wyburzeniowych ST-2200 i ST-2200A (trzpień sześciokątny Hex)



Do mini młotków wyburzeniowych ST-2200 i ST-2200A (trzpień okrągły)



Do młotków wyburzeniowych ST-2201, ST-2202, ST-2203, ST-2204 1"- 4" (trzpień sześciokątny Hex)



Do młotków wyburzeniowych ST-2201, ST-2202, ST-2203, ST-2204 1"- 4" (trzpień okrągły)



Dłuta do młotków ścinaków

Do ścinaków z trzpieniem sześciokątnym - HEX w/15mm (ST-2273, ST-2554F)

ST-2031/H 100 mm

ST-2032/H 75 mm

ST-2033/H 50 mm

ST-2034/H 40 mm



Sprężyny mocujące

ST-2001

ST-2006

2215-RS

ST-2002

ST-2009

ST-2009A





ST-6615

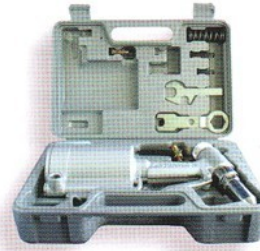

ST-6615K



ST-6355



ST-66154



ST-6356

Model	Zakres nitowania cale(mm)	Siła ciągu	Długość skoku	Wysokość	Przyłącze (PT)	Średnica przewodu (∅)	Szczęki	Waga
		kg	mm	mm				kg
ST-66154	3/16"(4.8), 1/4"(6.4), 1/8"(3.2), 5/32"(4.0)	1022	17	269	1/4"	10	2	1.95
ST-6615	3/32"(2.4), 1/8"(3.2), 5/32"(4.0), 3/16"(4.8)	720	14	273	1/4"	10	2	1.5
ST-6355	M3; M4; M5; M6; M8; M10; M12	2176	7	335	1/4"	10	-	2.45
ST-6356	M4; M5; M6; M8; M10; M12	2727	16,5	355	1/4"	10	-	3.95

Piły pneumatyczne

ST-66002



ST-66005



ST-6611



Model	Grubość ciętej blachy stalowej (mm)	Uderzeń /min	Skok tłoka	Zużycie powietrza		Przyłącze powietrza	Średnica węża zasilającego	Waga kg	Długość mm
			mm	cfm	l/min				
ST-66002	3	9500	10	6	170	1/4"	3/8"	1.72	238
ST-66005	3	9500	10	6	170	1/4"	3/8"	1.51	263
ST-6611	3	10000	10	9	255	1/4"	3/8"	1.23	17

ST-6614



ST-6620



ST-6621



ST-6655



ST-6634



ST-6656



ST-6652
ST-6652A



ST-6653



ST-6653A



ST-M3062



ST-C630



ST-6636CL-6

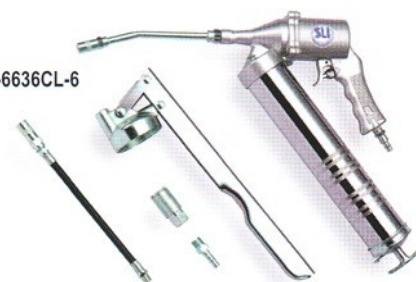

Model	Długość cięcia (inch)	Rozmiar pada (inch)	Prędkość bez obciążenia	Przyłącze powietrza	Średnica węża zasilającego	Zużycie powietrza		Całkowita długość (mm)	Masa (kg)
						cfm	l/min		
ST-6614	3	-	20000	3/8"	1/4"	6.0	170	200	1.30
ST-M3062		2	15000	1/4"	3/8"	3.0	85	182	0.71

Model	Grubość cięcia		Obroty (obr/min)	Zużycie powietrza		Waga kg	Długość mm
	Stal	Aluminium		cfm	l/min		
ST-6620	16	14	2200	6	170	-	-
ST-6621	16	14	2200	6	170	-	-
ST-6655	-	-	2500	4	90	1.1	227
ST-6634	-	-	4000	6	170	0.98	200
ST-6656	16	14	3200	6	170	-	-

Model	Max grubość blachy (mm)	Średnica otworu (Dia.) (mm)	Waga (kg)	Długość (mm)
ST-6652A	1.6(1.4)	5(8)	1.3	250
ST-6653A	1.6(1.4)	5(8)	1	190

Model	Pojemność		Wymiary (mm L x mm φ)
	Pojemność wkładu (oz)	Objętość (c.c)	
ST-C630	14	400	410.0 x 49.0
ST-6636CL-6	16	500	398.0 x 62.5



80/16



90/25



92/25



90/40



92/40



80/16

Model	Modele kompatybilne	Zszywka				Parametry narzędzia			
		Korona (mm)	Grubość (mm)	Szerokość (mm)	Długość (mm)	Ciśnienie robocze (bar)	Wymiary (wys. x szer. x dł.)(mm)	Waga (kg)	Pojemność magazynka
80/16	BEA 80 MODEL	12.9	0,65	0.95	6 - 16	4.13 - 6.8	195 x 59 x 245	0.9	160 sztuk
90/25	SENCO L BEA 190/25-103	5.8	1.0	1.25	10 - 25	4.13 - 6.8	195 x 59 x 245	1.2	100 sztuk
92/25	PREBENA 2M-H-25P	8.7	1.0	1.25	10 - 25	4.13 - 6.8	195 x 59 x 245	1.2	100 sztuk
90/40	SENCO L BEA 90/40	5.8	1.0	1.25	19 - 40	4.48 - 7.58	270 x 77 x 360	2.1	200 sztuk
92/40	BEA 92/38-151	8.7	1.0	1.25	19 - 40	4.48 - 7.58	270 x 77 x 360	2.1	160 sztuk
E80/16	-	12.9	0.65	1.25	6 - 16	zasilany elektr.	195 x 68 x 215	1.23	100 sztuk



SS-1183



SC-001



ST-6640



ST-66411



SA-6600A



SA-6612



SA-1033



SA-1032



DG-10L



DG-10-2



DG-10-1



SA-2001A



ST-6634P



SA-3340A



SA-2202



SA-3920

Pistolety lakiernicze



SS-1101



SS-1102

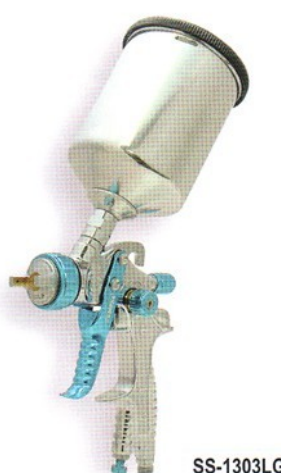

SS-1303LG



SS-1305HS

Model	Dysza mm	Dysze opcjonalnie (mm)	Pojemność kubka (l.)	Zużycie powietrza		Masa (kg)	Ciśnienie pracy	
				cfm	l/min		psi	kg/cm ²
SS-1101	0.8	1.0, 1.2	0.125	4.5	120	0.3	50-80	3.6-5.7
SS-1102	1.4	1.7, 2.0	0.6	8.8	250	0.47	50-80	3.6-5.7
SS-1303LG	1.4	1.7, 2.0, 2.5	0.6	3.0	85	0.7	23	1.6
SS-1305HS	1.5	1.8, 2.0, 2.5	1.0	6.2	175	0.85	29	2.0

Aerografy



SB-1101



SB-1102



SB-1105

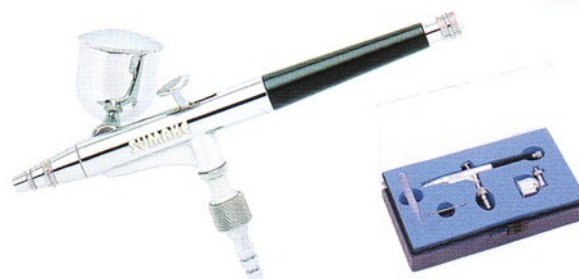

SB-1107

Model	Dysza (mm)	Ciśnienie robocze (psi)	Zużycie powietrza cfm	Pojemność zbiornika (c.c.)
SB-1101	1000	0.05-0.2	7.0	7.0
SB-1102	1000	0.1-0.8	7.0	7.0
SB-1105	1800	0.3-1.7	10.0	10.0
SB-1107	2200	0.3-2.0	10.0	10.0

Zwijadła

 HR041212
 HR0414510
 HR041215

HR0214520



HR-4600



Model	Rozmiar max. węża (mm)		Ciśnienie pracy bar	Ciśnienie rozrywające wąż bar	Długość węża (m)	Typ węża	Temp. pracy (°C)	Kolor węża	Kolor obudowy
	I.D.	O.D.							
HR041212	8	12	15	60	12	PU	-5 - +60	Niebieski	Żółty
HR041215	8	12	15	60	15	PU	-5 - +60	Niebieski	Żółty
HR0414510	10	14.5	15	60	10	PU	-5 - +60	Niebieski	Żółty
HR0214520	10	14.5	15	60	20	PU	-5 - +60	Nieb., Czer., Pomarańcz.	Czar., Czer.
HR-4600	10	16	20.4	68	15	PVC Zbrojony PU Gumowy	-20 - +70	Czerwony	Czarny

Przewody spiralne

 SPU-08-05
 SPU-08-10
 SPU-08-15
 SPU-08-20

 SPU-12-05
 SPU-12-10
 SPU-12-15
 SPU-12-20

SPU-16-10



Model	Średnica węża zew./wew. (mm)	Długość węża (mb)
SPU-08-05	08/05	12
SPU-08-10	08/05	15
SPU-08-15	08/05	10
SPU-08-20	08/05	20
SPU-12-05	12/08	12
SPU-12-10	12/08	15
SPU-12-15	12/08	10
SPU-12-20	12/08	20
SPU-16-10	16/10	12



SB-1.2
SB-2.0
SB-3.0



SA-2201
SA-2203
SA-2203
SA-2204
SA-2207



SA-2204A
SA-2204B



SA-22015



SA-22030
SA-22050
SA-22070
SA-22090A



SA-22090
SA-2215



SA-22015T
SA-22030T
SA-22050T



SA-2206
SA-2206A



HR-0130
HR-0180

Model	Masa równoważna (kg)	Długość linki (m)
SB-1.2	0.5-1.2	1.6
SB-2.0	1.0-2.0	1.6
SB-3.0	2.0-3.0	1.6
SA-2201	0.3-0.8	1.4
SA-2203	0.6-1.5	1.4
SA-2203-1	1.0-2.0	1.4
SA-2204	1.5-3.0	1.1

Model	Masa równoważna (kg)	Długość linki (m)
SA-2204A	0.8-2.0	1.5
SA-2204B	0.3-1.2	1.5
SA-2207	3.5-5.0	1.1
SA-22070	5.0-7.0	1.3
SA-22090A	7.0-9.0	1.3
SA-22015	0.5-1.5	1.3
SA-22030	1.5-3.0	1.3

Model	Masa równoważna (kg)	Długość linki (m)
SA-22050	3.0-5.0	1.3
SA-22090	5.0-9.0	1.3
SA-2215	9.0-15.0	1.3
SA-22015T	0.5-1.5	1.4
SA-22030T	1.5-3.0	1.4
SA-22050T	3.0-5.0	1.4

Model	Średnica przewodu		Ciśnienie pracy		Ciśnienie max.		Długość przewodu		Typ przewodu	Temperatura pracy (°C)	Kolor przewodu	Kolor obudowy
	∅ wew.	∅zew.	psi	bar	psi	bar	ft	m				
SA-2206	5	8	100	7	400	28	4	1.2	PU	-5 ~ +60	Niebieski	Szary
SA-2206A	5	8	100	7	400	28	6.6	2	PU	-5 ~ +60	Niebieski	Szary
HR-0130	6.5	9.5	100	7	400	28	20	6	PU	-5 ~ +60	Pomarańcz, Niebieski	Żółty
HR-0180	5	8	100	7	400	28	25	7.5	PU	-5 ~ +60	Pomarańcz, Niebieski	Żółty



AC 2000



AC 2000



AC 3000



AC 4000



AC 5000



AC 2000



AC 2000



AC 3000



AC 4000



AC 5000

Model	Wielkość przyłącza	Przepływ (l/min)	Zakres ciśnienia wyjściowego (bar)	Dokładność filtra (µm)
AC 1000	M5	200	0.5 - 8.5	25
AC 2000	1/4"	500	0.5 - 8.5	25
AC 3000	3/8"	1700	0.5 - 8.5	25
AC 4000	1/2"	3000	0.5 - 8.5	25
AC 5000	1"	4000	0 - 10	25

Model	Wielkość przyłącza	Przepływ (l/min)	Zakres ciśnienia wyjściowego (bar)	Dokładność filtra (µm)
AW 1000	M5	200	0 - 10	25
AW 2000	1/4"	550	0 - 10	5
AW 3000	3/8"	2000	0 - 10	5
AW 4000	1/2"	4000	0 - 10	5
AW 5000	1"	5500	0 - 10	25



AR 1000



AR 2000



AR 3000



AR 4000



AR 5000



AL 2000

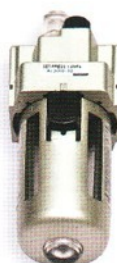

AL 3000

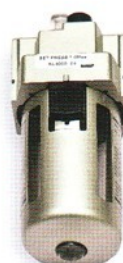

AL 4000



AL 5000

Model	Wielkość przyłącza	Przepływ (l/min)	Zakres ciśnienia wyjściowego (bar)
AR 1000	M5	200	0.5 - 10
AR 2000	1/4"	550	0.5 - 10
AR 3000	3/8"	2500	0.5 - 8.5
AR 4000	1/2"	6000	0.5 - 8.5
AR 5000	1"	8000	0.5 - 8.5

Model	Wielkość przyłącza	Przepływ (l/min)	Zakres ciśnienia wyjściowego (bar)	Waga (kg)
AL 2000	1/4"	1600	0 - 10	0.11
AL 3000	3/8"	3100	0 - 10	0.26
AL 4000	1/2"	8850	0 - 10	0.50
AL 5000	1"	9000	0 - 10	1.12

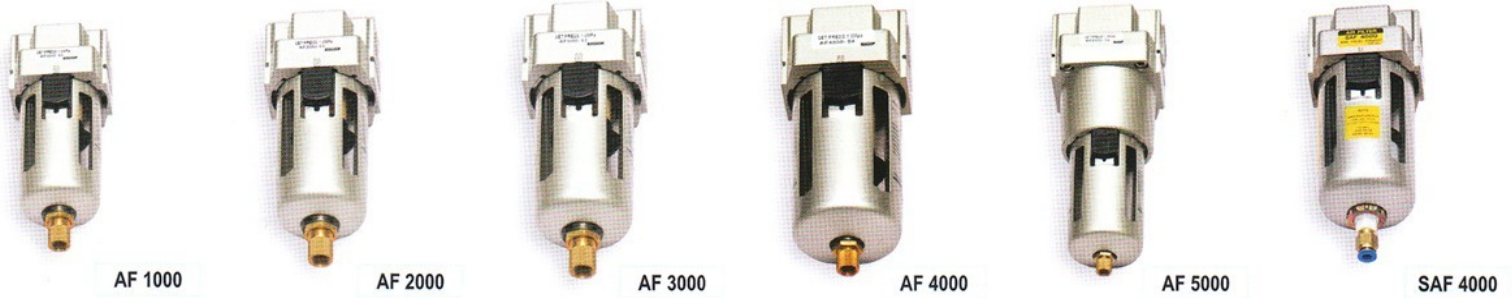

Model	Wielkość przyłącza	Przepływ (l/min)	Dokładność filtra (µm)
AF 1000	M5	110	25
AF 2000	1/4"	750	25
AF 3000	3/8"	1500	25
AF 4000	1/2"	4000	25
AF 5000	1"	7000	25

Model	Wielkość przyłącza	Przepływ (l/min)	Dokładność filtra (µm)
SAF 4000	1/2"	4000	5
SAFD 4000	1/2"	600	0.01
SAFL 350	1/2"	1500	3
SAFL 450	3/4"	2200	3
SAFL 550	1"	3600	3
SAFL 650	1 1/2"	6000	3
SAFL 850	2"	12000	3



Model	Wielkość przyłącza	Przepływ (l/min)	Dokładność filtra (µm)
SAM 350	1/2"	1500	0.3
SAM 450	3/4"	2200	0.3
SAM 550	1"	3600	0.3
SAM 650	1 1/2"	6000	0.3
SAM 850	2"	12000	0.3

Model	Wielkość przyłącza	Przepływ (l/min)	Dokładność filtra (µm)
SAMD 350	1/2"	1100	0.01
SAMD 450	3/4"	2100	0.01
SAMD 550	1"	3500	0.01
SAMD 650	1 1/2"	6000	0.01
SAMD 850	2"	12000	0.01

Cechy

- Nowoczesne rozwiązanie łączące zasilanie ze zliczaniem wkrętów
- Kompatybilny z systemem kontroli procesu opartym na PLC, dokładne zliczanie mocowania wkrętów
- Wbudowana funkcja "uczenia się" umożliwia dobranie najlepszych ustawień
- Możliwość ustawienia szybkości i czasu pracy za pomocą funkcji wolnego startu
- Możliwość wyboru automatycznego lub manualnego restartu
- Rozszerzony tryb czasowy umożliwia symulację długości montażu poszczególnych wkrętów
- Wyświetla ilość niedokończonych zliczeń wkrętów, użytkownik może dodać zewnętrzny czujnik aby zapobiec błędom
- Głośniczek informuje o każdym zakończonym cyklu zamocowania wkrętu. Wewnętrzny sygnał wykrywający zliczanie wkrętów można podłączyć do urządzeń zewnętrznych
- Dostosowany do półautomatycznych i automatycznych linii produkcyjnych



SP-BC32HL60T/C

- Napięcie wejściowe AC 100-240V 50/60 HZ
- Napięcie wyjściowe DC 32V/20V 1.5 A
- Licznik 1-99
- Metoda liczenia zliczanie w górę / zliczanie w dół
- Praca z czujnikiem ON / OFF
- Regulacja czasu - wolny start 0-9.9 sekund
- Regulacja prędkości - wolny start 30% - 100% L0-L9 zadanej prędkości
- Czas działania - wartość początkowa 0.0-0.99 sekund
- Czas działania - wartość końcowa 0.0-9.9 sekund
- NG alarm On/ Off/ FF/ EF z diodą i sygn. z głośniczka
- OK alarm On/ Off/ FF/ EF z diodą i sygn. z głośniczka
- Automatyczne zerowanie ON / OFF
- Wejścia zewnętrzne Czujnik / Reset
- Wyjścia zewnętrzne OK/ NG/ OK ALL
- Kontrola wkrętarki Prędkość: HI/ LO i Wolny Start
- Wymiary zewnętrzne 150*48*130 (mm)

Wkrętarki przeznaczone do pracy z zasilaczem z licznikiem wkrętów



Model	Zakres momentu obrotowego ±3%		Prędkość bez obciążenia (obr/min)		Średnica wkrętów		Waga (g)	Długość (mm)	Zasilanie	Rodzaje bitów
	kgf-cm	N.m	HI	LO	otwory gwintowane ∅ (mm)	samogwintujących ∅ (mm)				
EA-BC203L	0.2-3.5	0.02-0.34	1000	700	1.0-2.3	1.0-2.0	385	185	DC20Vor32V	B HEX 6.35mm
EA-BC207L	0.5-7.0	0.05-0.69	1000	700	1.4-2.6	1.4-2.3	385	185	DC20Vor32V	C ∅4mm
EA-BC210L	1.0-10.0	0.10-0.98	1000	700	1.6-3.0	1.6-2.6	385	185	DC20Vor32V	
EA-BC412L	1.5-12.0	0.15-1.18	1000	650	1.6-3.0	1.6-2.6	520	245	DC20Vor32V	A HEX 5mm
EA-BC412P	1.5-12.0	0.32-1.18	1000	650	1.6-3.0	1.6-2.6	520	245	DC20Vor32V	B HEX 6.35mm
EA-BC412LH	1.5-12.0	0.15-1.18	2000	X	1.6-3.0	1.6-2.6	520	245	DC20Vor32V	
EA-BC412PH	1.5-12.0	0.15-1.18	2000	X	1.6-3.0	1.6-2.6	520	245	DC20Vor32V	C ∅4mm
EA-BC419L	3.0-19.0	0.29-1.86	1000	650	2.3-3.5	2.3-3.0	520	245	DC20Vor32V	D ∅5mm
EA-BC419P	3.0-19.0	0.29-1.86	1000	650	2.3-3.5	2.3-3.0	520	245	DC20Vor32V	

*ZALECENIE: modele o wysokich obrotach NIE SĄ PRZYSTOSOWANE do pracy z zasilaczem w trybie niskich obrotów

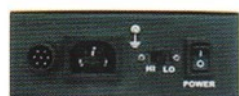

SP-C32HL60T/C

- Napięcie wejściowe AC 100-240V 50/60 HZ
- Napięcie wyjściowe DC 32V/20V 1.5 A
- Licznik 1-99
- Metoda liczenia zliczanie w górę / zliczanie w dół
- Praca z czujnikiem ON / OFF
- Regulacja czasu - wolny start 0-9.9 sekund
- Regulacja prędkości - wolny start 60% - 100% zadanej prędkości
- Czas działania - wartość początkowa 0.0-0.99 sekund
- Czas działania - wartość końcowa 0.0-9.9 sekund
- NG alarm On/ Off/ FF/ EF z diodą i sygn. z głośniczka
- OK alarm On/ Off/ FF/ EF z diodą i sygn. z głośniczka
- Automatyczne zerowanie ON / OFF
- Wejścia zewnętrzne Czujnik / Reset
- Wyjścia zewnętrzne OK/ NG/ OK ALL
- Kontrola wkrętarki Prędkość: HI/ LO i Wolny Start
- Wymiary zewnętrzne 150*45*130 (mm)



EA-C610LH
EA-C618L
EA-C624L
EA-C630L

Uruchamiana dźwignią



EA-C610PH
EA-C618P
EA-C624P
EA-C630P

Uruchamiana przyciskiem



EA-C712LH
EA-C723L
EA-C723L
EA-C748L

Uruchamiana dźwignią



EA-C712PH
EA-C723P
EA-C723P
EA-C748P

Uruchamiana przyciskiem



EA-C203L
EA-C207L
EA-C210L

Uruchamiana dźwignią



EA-C408LH
EA-C412L
EA-C416L

Uruchamiana dźwignią



EA-C408PH
EA-C412P
EA-C416P

Uruchamiana przyciskiem

Wkrętarki przeznaczone do pracy z zasilaczem z licznikiem wkrętów

Model	Zakres momentu obrotowego ±3%		Prędkość bez obciążenia (obr/min)		Średnica wkrętów		Waga (g)	Długość (mm)	Zasilanie	Rodzaje bitów
	kgf-cm	N.m	HI	LO	otwory gwintowane ∅ (mm)	samogwintujących ∅ (mm)				
EA-C203L	0.2-3.5	0.02-0.34	1000	600	1.0-2.3	1.0-2.0	270	205	DC20Vor32V	B HEX 6.35mm
EA-C207L	0.5-7.0	0.05-0.69	1000	600	1.4-2.6	1.4-2.3	270	205	DC20Vor32V	C ∅4mm
EA-C210L	1.0-10.0	0.10-0.98	670	400	1.6-3.0	1.6-2.6	270	205	DC20Vor32V	A HEX 5mm
EA-C408LH	1.0-8.0	0.10-0.78	2000	X	1.6-3.0	1.6-2.6	480	230	DC20Vor32V	B HEX 6.35mm
EA-C408PH	1.0-8.0	0.10-0.78	2000	X	1.6-3.0	1.6-2.6	480	230	DC20Vor32V	C ∅4mm
EA-C412L	1.0-12.0	0.10-1.18	1000	600	1.6-3.0	1.6-2.6	480	230	DC20Vor32V	D ∅5mm
EA-C412P	1.0-12.0	0.10-1.18	1000	600	1.6-3.0	1.6-2.6	480	230	DC20Vor32V	A HEX 5mm
EA-C416L	3.0-16.0	0.29-1.57	1000	600	2.3-3.5	2.3-3.0	480	230	DC20Vor32V	B HEX 6.35mm
EA-C416P	3.0-16.0	0.29-1.57	1000	600	2.3-3.5	2.3-3.0	480	230	DC20Vor32V	C ∅4mm
EA-C610LH	2.0-10.0	0.20-0.98	2000	X	2.0-3.0	2.0-2.6	600	260	DC20Vor32V	D ∅5mm
EA-C610PH	2.0-10.0	0.20-0.98	2000	X	2.0-3.0	2.0-2.6	600	260	DC20Vor32V	A HEX 5mm
EA-C618L	5.0-18.0	0.50-1.76	1000	600	2.0-3.5	2.0-3.0	600	260	DC20Vor32V	B HEX 6.35mm
EA-C618P	5.0-18.0	0.50-1.76	1000	600	2.0-3.5	2.0-3.0	600	260	DC20Vor32V	C ∅4mm
EA-C624L	7.0-24.0	0.69-2.35	750	450	2.6-4.0	2.6-3.5	600	260	DC20Vor32V	D ∅5mm
EA-C624P	7.0-24.0	0.69-2.35	750	450	2.6-4.0	2.6-3.5	600	260	DC20Vor32V	A HEX 5mm
EA-C630L	8.0-30.0	0.78-2.94	530	300	3.0-5.0	3.0-4.0	600	260	DC20Vor32V	B HEX 6.35mm
EA-C630P	8.0-30.0	0.78-2.94	530	300	3.0-5.0	3.0-4.0	600	260	DC20Vor32V	C ∅4mm
EA-C712LH	5.0-12.0	0.50-1.18	2000	X	2.3-3.5	2.0-3.0	700	270	DC20Vor32V	D ∅5mm
EA-C712PH	5.0-12.0	0.50-1.18	2000	X	2.3-3.5	2.0-3.0	700	270	DC20Vor32V	A HEX 5mm
EA-C723L	6.0-23.0	0.59-2.25	1000	600	2.6-4.0	2.6-3.5	700	270	DC20Vor32V	B HEX 6.35mm
EA-C723P	6.0-23.0	0.59-2.25	1000	600	2.6-4.0	2.6-3.5	700	270	DC20Vor32V	C ∅4mm
EA-C732L	10.0-32.0	0.98-3.14	750	450	3.0-5.0	3.0-4.5	700	270	DC20Vor32V	D ∅5mm
EA-C732P	10.0-32.0	0.98-3.14	750	450	3.0-5.0	3.0-4.5	700	270	DC20Vor32V	A HEX 5mm
EA-C748L	16.0-48.0	1.57-4.70	530	300	4.0-6.0	3.0-5.0	700	270	DC20Vor32V	B HEX 6.35mm
EA-C748P	16.0-48.0	1.57-4.70	530	300	4.0-6.0	3.0-5.0	700	270	DC20Vor32V	C ∅4mm

Standardowy bit : B - HEX 6.35 mm

*ZALECENIE: modele o wysokich obrotach NIE SĄ PRZYSTOSOWANE do pracy z zasilaczem w trybie niskich obrotów

Cechy

- wbudowany silny magnes
- ergonomiczna konstrukcja zmniejsza zmęczenie operatora
- łatwość obsługi przy doskonałej efektywności
- doskonale dostosowanie do typowych operacji
- sterowanie pojedynczym przyciskiem
- dokładność momentu: +/- 3%

PODŁĄCZANE BEZPOŚREDNIO

- Zakres momentu obrotowego: 1.5 - 19 kgf-cm



Uruchamiana
dźwignią

ED-212L2
ED-212LH2 *wysokie obroty*
ED-219L2



Uruchamiana
przyciskiem

ED-212P2
ED-212PH2 *wysokie obroty*
ED-219P2

Wymiary zewnętrzne w (mm)

Uruchamiana dźwignią

ED-212L2 ED-212LH2 ED-219L2

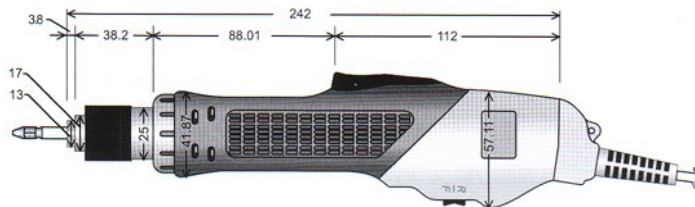

Uruchamiana przyciskiem

ED-212P2 ED-212PH2 ED-219P2

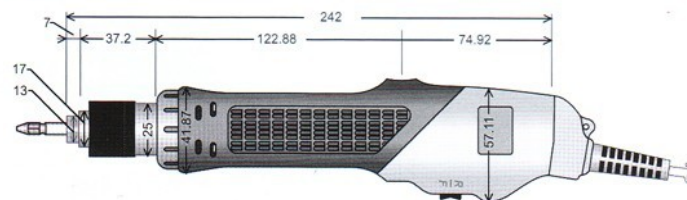

Krzywa momentu obrotowego

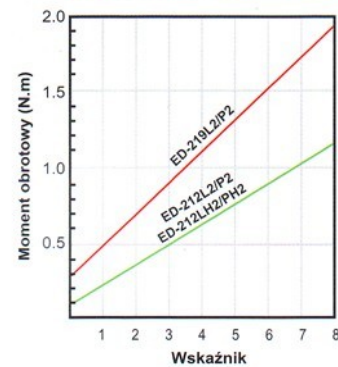

Model	Zakres momentu obrotowego ±3%		Prędkość bez obciążenia (obr/min)	Średnica wkrętów		Waga (g)	Długość (mm)	Zasilanie (V)	Rodzaje bitów
	kgf-cm	N.m		otwory gwintowane ∅ (mm)	samogwintujących ∅ (mm)				
ED-212L2	1.5-12.0	0.15-1.18	1000	1.6-3.0	1.6-2.6	550	242	230	A HEX 5mm B HEX 6.35mm C ∅ 4mm D ∅ 5mm
ED-212P2	1.5-12.0	0.15-1.18	1000	1.6-3.0	1.6-2.6	550	242	230	
ED-212LH2	1.5-12.0	0.15-1.18	2000	1.6-3.0	1.6-2.6	550	242	230	
ED-212PH2	1.5-12.0	0.15-1.18	2000	1.6-3.0	1.6-2.6	550	242	230	
ED-219L2	3.0-19.0	0.29-1.86	1000	2.6-3.5	2.6-3.0	550	242	230	
ED-219P2	3.0-19.0	0.29-1.86	1000	2.6-3.5	2.6-3.0	550	242	230	

Standardowy bit: B - HEX 6.35 mm

PODŁĄCZANE BEZPOŚREDNIO

• Zakres momentu obrotowego: 5 - 45 kgf-cm



Lever Start Type

Uruchamiana
dźwignią

ED-617LH2 duża prędkość
ED-622L2
ED-630L2
ED-630LH2 duża prędkość
ED-645L2



Push to Start Type

Uruchamiana
przyciskiem

ED-617PH2 duża prędkość
ED-622P2
ED-630P2
ED-630PH2 duża prędkość
ED-645P2

Wymiary zewnętrzne w (mm)

Uruchamiana dźwignią Lever Start Type

ED-617LH2 ED-622L2 ED-630L2 ED-630LH2 ED-645L2

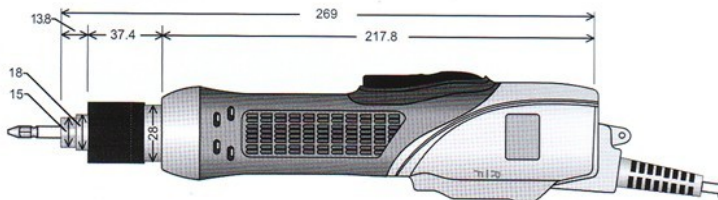

Uruchamiana przyciskiem Push to Start Type

ED-617PH2 ED-622P2 ED-630P2 ED-630PH2 ED-645P2

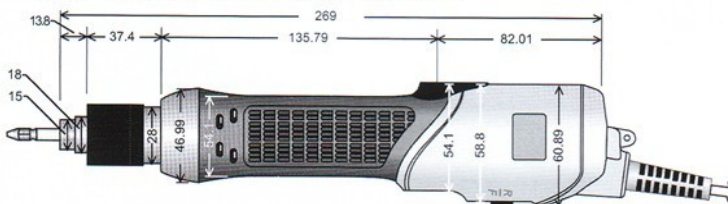

Krzywa momentu obrotowego

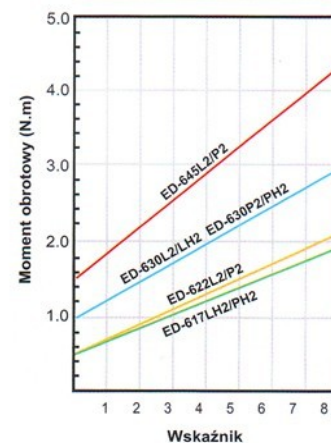

Model	Zakres momentu obrotowego ±3%		Prędkość bez obciążenia (obr/min)	Średnica wkrętów		Waga (g)	Długość (mm)	Zasilanie (V)	Rodzaje bitów
	kgf-cm	N.m		otwory gwintowane ∅ (mm)	samogwintujących ∅ (mm)				
ED-617LH2	5.0-17.0	0.5-1.67	1900	2.3-4.0	2.3-3.5	700	269	230	A HEX 5 mm B HEX 6.35mm
ED-617PH2	5.0-17.0	0.5-1.67	1900	2.3-4.0	2.3-3.5	700	269	230	
ED-622L2	5.0-22.0	0.49-2.16	1000	2.6-4.0	2.6-3.5	700	269	230	
ED-622P2	5.0-22.0	0.49-2.16	1000	2.6-4.0	2.6-3.5	700	269	230	
ED-630L2	10.0-30.0	0.98-2.94	700	3.0-5.0	3.0-4.0	700	269	230	
ED-630P2	10.0-30.0	0.98-2.94	700	3.0-5.0	3.0-4.0	700	269	230	
ED-630LH2	10.0-30.0	0.98-2.94	1000	3.0-5.0	3.0-4.0	700	269	230	
ED-630PH2	10.0-30.0	0.98-2.94	1000	3.0-5.0	3.0-4.0	700	269	230	
ED-645L2	15.0-45.0	1.47-4.41	500	4.0-6.0	4.0-5.0	700	269	230	
ED-645P2	15.0-45.0	1.47-4.41	500	4.0-6.0	4.0-5.0	700	269	230	

Standardowy bit: B - HEX 6.35 mm

PODŁĄCZANE BEZPOŚREDNIO

• Zakres momentu obrotowego: 5 - 20 kgf-cm



Lever Start Type
Uruchamiana dźwignią
ED-513LH2 *wysokie obroty*
ED-520L2



Push to Start Type
Uruchamiana przyciskiem
ED-513PH2 *wysokie obroty*
ED-520P2

Wymiary zewnętrzne w (mm)

Uruchamiana dźwignią Lever Start Type

ED-513LH2 ED-520L2

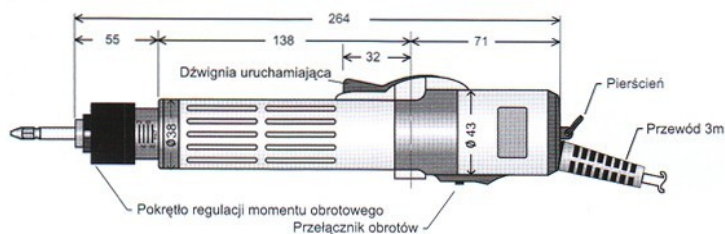

Uruchamiana przyciskiem Push to Start Type

ED-513PH2 ED-520P2

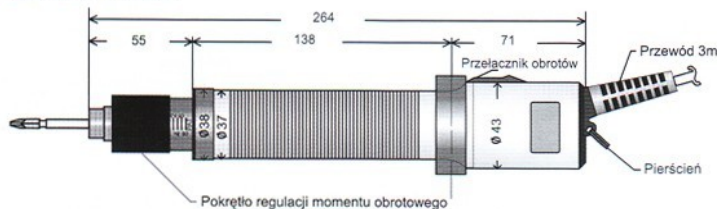

Krzywa momentu obrotowego

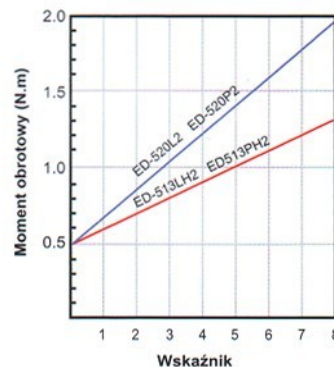

Model	Rodzaje bitów
ED-513LH2	A HEX 5 mm
ED-520L2	B HEX 6.35mm
ED-513PH2	D Ø 5mm
ED-520P2	

Standardowy bit: B - HEX 6.35 mm

Model	Zakres momentu obrotowego ±3%		Prędkość bez obciążenia (obr/min)	Średnica wkrętów		Waga (g)	Długość (mm)	Zasilanie (V)
	kgf-cm	N.m		otwory gwintowane ∅ (mm)	samogwintujących ∅ (mm)			
ED-513LH2	5.0-13.0	0.5-1.27	2000	2.0-3.5	2.0-3.0	620	264	230
ED-513PH2	5.0-13.0	0.5-1.27	2000	2.0-3.5	2.0-3.0	620	264	230
ED-520L2	5.0-20.0	0.5-1.96	1000	2.6-4.0	2.6-3.5	620	264	230
ED-520P2	5.0-20.0	0.5-1.96	1000	2.6-4.0	2.6-3.5	620	264	230

Cechy

- duży wybór zakresu momentu obrotowego - uniwersalność każdego modelu
- ekonomiczne rozwiązanie dla typowych zastosowań
- zewnętrzna regulacja momentu obrotowego - łatwa i bezpieczna za pomocą pokrętki
- łatwe w utrzymaniu zewnętrznie wymienne szczotki
- dokładność momentu: +/- 5%

PODŁĄCZANE BEZPOŚREDNIO

- Zakres momentu obrotowego: 0.5 - 45 kgf-cm



Lever Start Type
Uruchamiana
dźwignią

ES-207L2
ES-215L2



Lever Start Type
Uruchamiana
dźwignią

ES-618LH2
ES-625L2
ES-635L2
ES-645L2

Wymiary zewnętrzne w (mm)

Uruchamiana dźwignią Lever Start Type

ES-207L2 ES-215L2

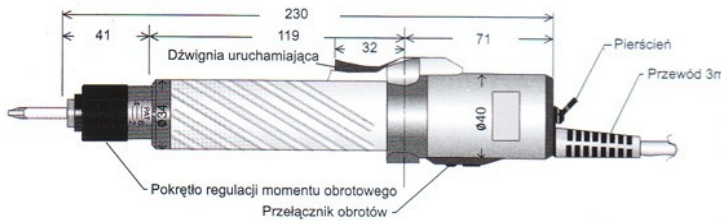

Uruchamiana dźwignią Lever Start Type

ES-618LH2 ES-625L2 ES-635L2 ES-645L2

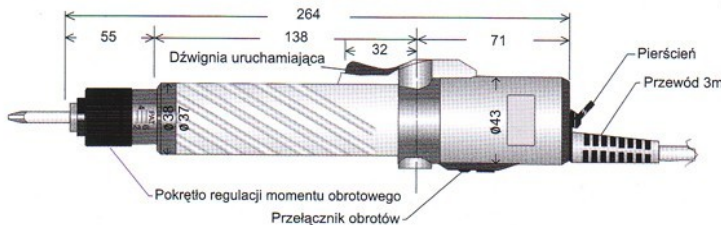

Krzywa momentu obrotowego

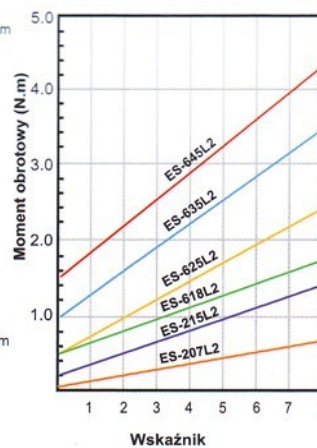

Model	Rodzaje bitów	
ES-207L2 ES-215L2	A HEX 5mm	
	B HEX 6.35mm	
	C ∅4mm	
	D ∅5mm	
ES-618LH2 ES-625L2 ES-635L2 ES-645L2	A HEX 5mm	
	B HEX 6.35mm	
	Standardowy bit: B - HEX 6.35 mm	

Model	Zakres momentu obrotowego +5%		Prędkość bez obciążenia (obr/min)	Średnica wkrętów		Waga (g)	Długość (mm)	Zasilanie (V)
	kgf-cm	N.m		otwory gwintowane ∅ (mm)	samogwintujących ∅ (mm)			
ES-207L2	0.5-7.0	0.05-0.69	1000	1.4-2.6	1.4-2.0	480	230	230
ES-215L2	2.0-15.0	0.19-1.47	1000	2.0-4.0	2.0-3.0	480	230	230
ES-618LH2	5.0-18.0	0.5-1.76	2000	2.6-4.0	2.6-3.5	600	264	230
ES-625L2	5.0-25.0	0.49-2.45	1000	2.6-4.0	2.6-3.5	600	264	230
ES-635L2	10.0-35.0	0.98-3.43	700	3.0-5.0	3.0-4.0	600	264	230
ES-645L2	15.0-45.0	1.47-4.41	500	4.0-6.0	4.0-5.0	600	264	230