

Przelotka 10mm PUC-10



hitech

model	PU-PUC-10
producent	Hi-Tech
wąż	Ø 10 mm
typ	przelotka

typ szybkozłączki: złączka prosta

wąż: 10mm

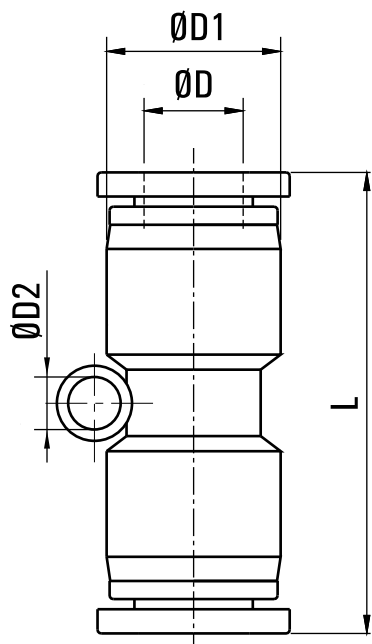

MODEL	$\varnothing D$	$\varnothing D1$	$\varnothing D2$	L
PUC-04	4	11.5	3.2	34
PUC-06	6	13.5	3.2	35.5
PUC-08	8	15	3.2	38.5
PUC-10	10	19	4.2	48
PUC-12	12	21.5	4.2	49
PUC-16	16	26.5	-	64