

## Przepustnica typu LUG DN100 - PN10/16



### PNEUMATIG

model	PGV-20L94E.DN100
producent	Pneumatig
średnica	DN100
ciśnienie robocze	PN10, PN16
długość zabudowy	ISO 5752 seria 20
kołnierz górny	ISO 5211

Średnica nominalna: DN100

Ciśnienie nominalne: PN10, PN16

Długość zabudowy: ISO 5752 krótka, seria 20

Kołnierz górny: ISO 5211

Waga: 8kg

Budowa

Korpus: żeliwo sferoidalne GJS-500-7

Wał: stal nierdzewna AISI 420

Dysk: stal nierdzewna CF8M

Uszczelnienie: EPDM

Na zamówienie dostępne wykonania z innych materiałów

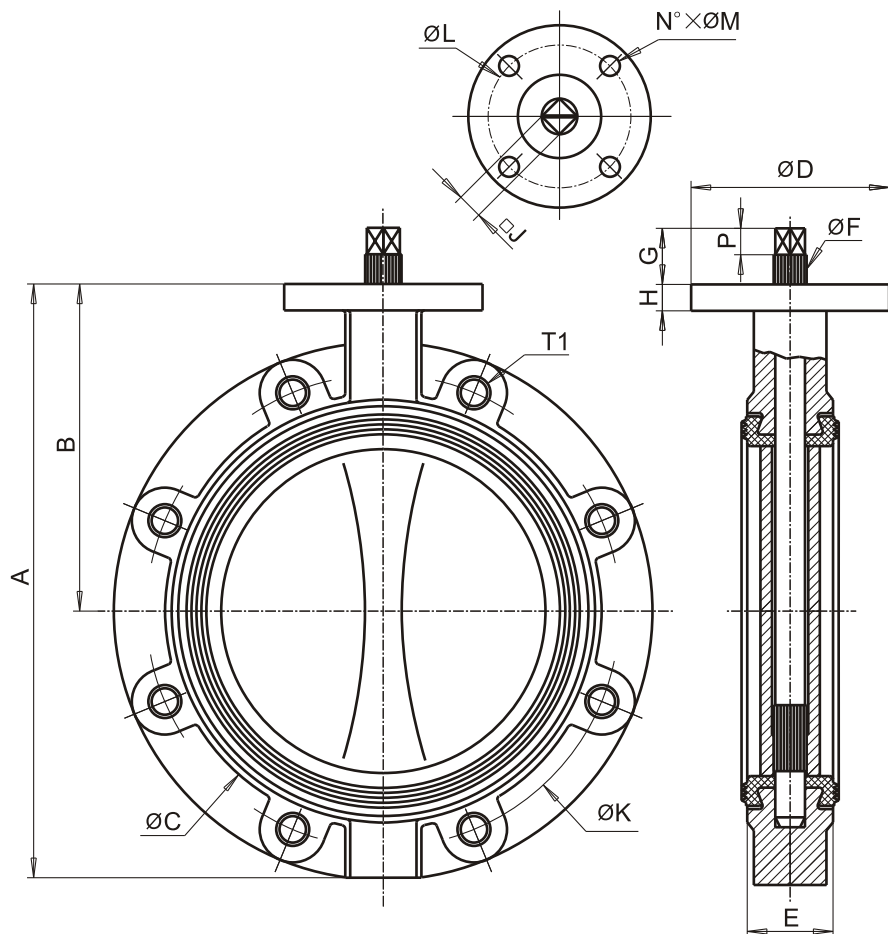

LUG														PN 10		PN 16		
DN		A	B	C	D	E	F	G	H	J	L	N°xM	P	WAGA WEIGHT	K	OTWORY GWINTOWANE THREADED HOLES	K	OTWORY GWINTOWANE THREADED HOLES
MM	"														N°xT1	N°xT1		
32	1 1/4"	206	140	83	88	33	10.5	30	24	8	70	4x9	17	3	100	4xM16	100	4xM16
40	1 1/2"	206	140	83	88	33	10.5	30	24	8	70	4x9	17	3	110	4xM16	110	4xM16
50	2"	226	156	100	88	43	10.5	30	24	8	70	4x9	17	3.5	125	4xM16	125	4xM16
65	2 1/2"	246	161	117	88	46	14.5	30	24	9	70	4x9	17	4.5	145	4xM16	145	4xM16
80	3"	259	169	134	88	46	16.5	30	24	11	70	4x9	17	6.5	160	8xM16	160	8xM16
100	4"	295	187	155	88	52	16.5	30	24	11	70	4x9	17	8	180	8xM16	180	8xM16
125	5"	325	206	181	105	56	18.5	30	24	14	70	4x9	17	11	210	8xM16	210	8xM16
150	6"	352	215	209	105	56	18.5	30	24	14	70	4x9	17	12	240	8xM20	240	8xM20
200	8"	422	255	267	105	60	22.5	30	24	17	70	4x9	17	18.5	295	8xM20	295	12xM20
250	10"	460	248	324	150	68	25.5	40	20	19	102	4x11	20	28.5	350	12xM20	355	12xM24
300	12"	523	280	373	150	78	30.5	40	20	22	102	4x11	20	42	400	12xM20	410	12xM24
350	14"	570	300	425	170	78	30.5	40	20	22	140	4x18	20	53	460	16xM20	470	16xM24
400	16"	644	340	480	170	102	35.5	40	20	27	140	4x18	20	77	515	16xM24	525	16xM27