

Przepustnica typu WAFER DN400 - PN10/16



PNEUMATIG

model	PG-PW-400
producent	Pneumatig
średnica	DN400
ciśnienie robocze	PN10, PN16
długość zabudowy	ISO 5752 seria 20
kołnierz górny	ISO 5211

Średnica nominalna: DN400

Ciśnienie nominalne: PN10, PN16

Długość zabudowy: ISO 5752 krótka, seria 20

Kołnierz górny: ISO 5211

Waga: 52kg

Budowa

Korpus: żeliwo sferoidalne GJS-500-7

Wał: stal nierdzewna AISI 304

Dysk: stal nierdzewna CF8M

Uszczelnienie: EPDM

Na zamówienie dostępne wykonania z innych materiałów

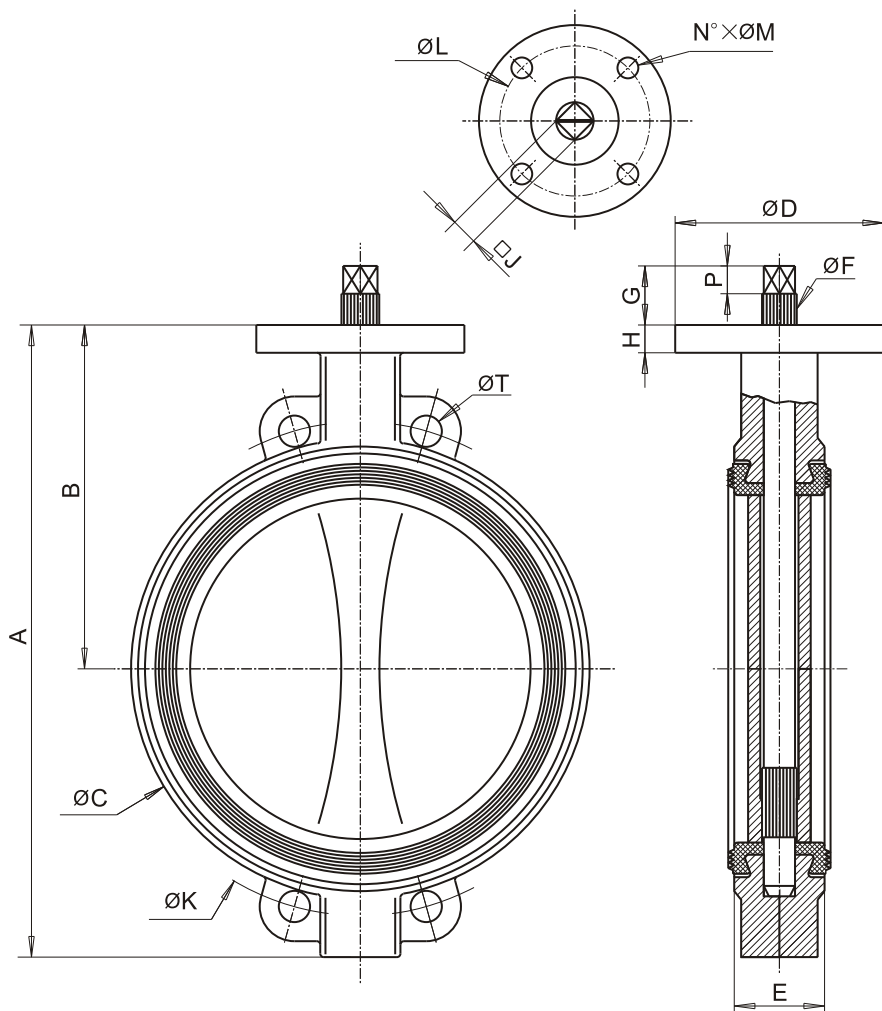

WAFER															PN 10		PN 16		
DN		A	B	C	D	E	F	G	H	J	L	N°xM	P	WAGA WEIGHT	K	OTWORY	K	OTWORY	
MM	"															HOLES		HOLES	
																N° x T		N° x T	
32	1 1/4"	205	140	82	88	33	10.5	30	24	8	70	4x9	17	2	100	4x18	100	4x18	
40	1 1/2"	205	140	82	88	33	10.5	30	24	8	70	4x9	17	2	110	4x18	110	4x18	
50	2"	228	156	103	88	43	10.5	30	24	8	70	4x9	17	3,5	125	4x18	125	4x18	
65	2 1/2"	248	161	117	88	46	14.5	30	24	9	70	4x9	17	4,5	145	4x18	145	4x18	
80	3"	256	169	134	88	46	16.5	30	24	11	70	4x9	17	5	160	4x18	160	4x18	
100	4"	298	187	153	88	52	16.5	30	24	11	70	4x9	17	6,5	180	4x18	180	4x18	
125	5"	331	206	182	105	56	18.5	30	24	14	70	4x9	17	8	210	4x18	210	4x18	
150	6"	349	215	209	105	56	18.5	30	24	14	70	4x9	17	9	240	4x23	240	4x23	
200	8"	430	255	270	105	60	22.5	30	24	17	70	4x9	17	15	295	4x23	295	4x23	
250	10"	461	248	320	150	68	25.5	40	20	19	102	4x11	20	21,5	350	4x23	355	4x27	
300	12"	524	280	374	150	78	30.5	40	20	22	102	4x11	20	30	400	4x23	410	4x27	
350	14"	570	300	426	170	78	30.5	40	20	22	140	4x18	20	39	460	4x23	470	4x27	
400	16"	644	340	486	170	102	35.5	40	20	27	140	4x18	20	52	515	4x27	525	4x30	