

## Redukcja 6/4 – 4/2 PG-06-04



**hitech**

model	PU-PG-06-04
producent	Hi-Tech
wąż	Ø 6 mm
wąż (r)	Ø 4 mm
typ	redukcja

typ szybkozłączki: złączka prosta

wąż: 6mm

wąż: 4mm

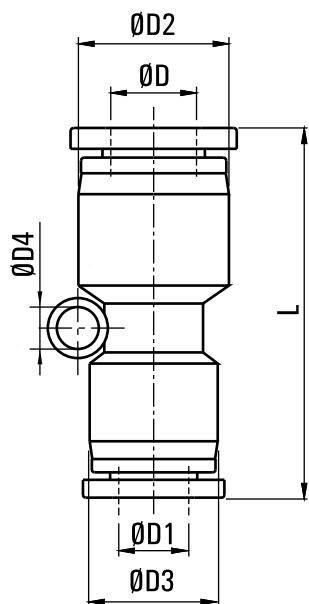

MODEL	$\varnothing D$	$\varnothing D1$	$\varnothing D2$	$\varnothing D3$	$\varnothing D4$	L
PG-06-04	6	4	13.5	11.5	3.2	34.5
PG-08-04	8	4	15	13.5	3.2	36.5
PG-08-06	8	6	15	13.5	3.2	36.5
PG-10-06	10	6	19	15	4.2	44
PG-10-08	10	8	19	15	4.2	44
PG-12-08	12	8	21.5	19	4.2	48
PG-12-10	12	10	21.5	19	4.2	49
PG-16-12	16	12	26.5	26.5	-	64