

Trójnik redukcyjny 06-04 PWJ-06-04



hitech

model	PU-PWJ-06-04
producent	Hi-Tech
wąż	Ø 6 mm
wąż (r)	Ø 4 mm
typ	redukcja, trójnik Y

typ szybkozłączki: trójnik Y

wąż: 6mm

wąż: 4mm

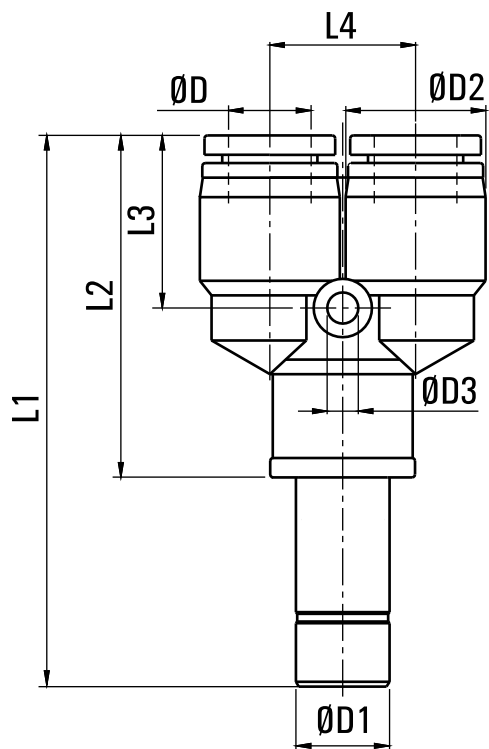

MODEL	ØD	ØD1	ØD2	ØD3	L1	L2	L3	L4
PWJ-06-04	4	6	11.5	3.2	52.8	33.8	14.5	11
PWJ-08-06	6	8	13.5	3.2	55.5	35	15	13
PWJ-10-06	8	10	15	3.2	62	37.3	18	15
PWJ-12-10	10	12	19	4.2	72.5	46.5	21	18