

Trójnik redukcyjny 06mm-2x 04mm PW-06-04



hitech

model	PU-PW-06-04
producent	Hi-Tech
wąż	Ø 6 mm
wąż (r)	Ø 4 mm
typ	redukcja, trójnik Y

typ szybkozłączki: trójnik Y

wąż: 6mm

wąż: 4mm

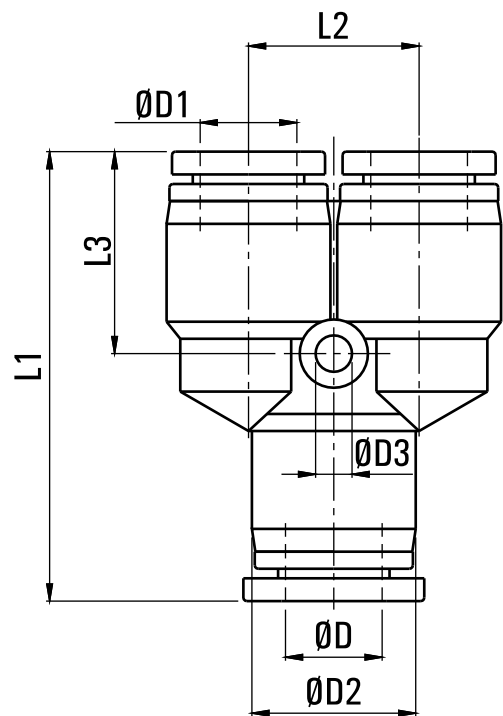

MODEL	ØD	ØD1	ØD2	ØD3	L1	L2	L3
PW-06-04	6	4	13.5	3.2	37.5	13	15
PW-08-04	8	4	15	3.2	39.8	15	18
PW-08-06	8	6	15	3.2	39.8	15	18
PW-10-08	10	8	19	4.2	50	18	21
PW-12-08	12	8	21.5	4.2	53	21	21.5
PW-12-10	12	10	21.5	4.2	53	21	21.5