

Trójnik T 12 1/2" PT-12-04



hitech

model	PU-PT-12-04
producent	Hi-Tech
wąż	Ø 12 mm
typ	trójnik T
przyłącze	G 1/2
rodzaj gwintu	zewnątrzny

typ szybkozłączki: trójnik T
przyłącze: 1/2
wąż: 12mm

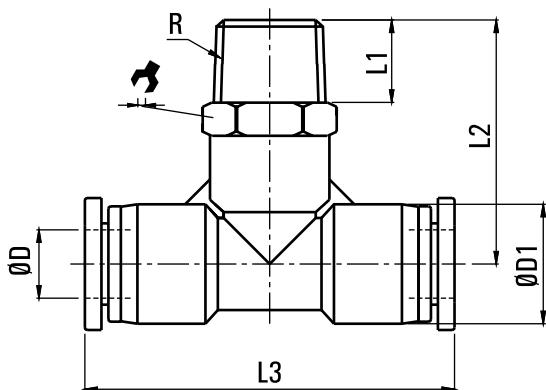

MODEL	ØD	R	L1	L2	L3	ØD1	↗
PT-04-M5	4	M5	3.5	21.3	38	11.5	10
PT-04-01	4	1/8"	7.5	23.8	38	11.5	10
PT-04-02	4	1/4"	9.5	26.8	38	11.5	14
PT-04-03	4	3/8"	10.5	28.3	38	11.5	17
PT-06-M5	6	M5	3.5	21.7	39	13.5	12
PT-06-01	6	1/8"	7.5	24.5	39	13.5	12
PT-06-02	6	1/4"	9.5	26.7	39	13.5	14
PT-06-03	6	3/8"	10.5	28.2	39	13.5	17
PT-06-04	6	1/2"	13.5	31.7	39	13.5	21
PT-08-01	8	1/8"	7.5	27.5	45	15	14
PT-08-02	8	1/4"	9.5	29.5	45	15	14
PT-08-03	8	3/8"	10.5	31	45	15	17
PT-08-04	8	1/2"	13.5	34.5	45	15	21

MODEL	ØD	R	L1	L2	L3	ØD1	↗
PT-10-01	10	1/8"	7.5	32.8	57	19	17
PT-10-02	10	1/4"	9.5	34.8	57	19	17
PT-10-03	10	3/8"	10.5	35.8	57	19	17
PT-10-04	10	1/2"	13.5	39.3	57	19	21
PT-12-01	12	1/8"	7.5	33.5	59	21.5	21
PT-12-02	12	1/4"	9.5	36	59	21.5	21
PT-12-03	12	3/8"	10.5	37	59	21.5	21
PT-12-04	12	1/2"	13.5	40	59	21.5	21
PT-16-03	16	3/8"	10.5	44	66	26.5	24
PT-16-04	16	1/2"	13.5	47	66	26.5	24