

Trójnik T 12mm 3/8" PST-12-03



hitech

model	PU-PST-12-03
producent	Hi-Tech
wąż	Ø 12 mm
typ	trójnik T
przyłącze	G 3/8
rodzaj gwintu	zewnątrzny

typ szybkozłączki: trójnik T
przyłącze: 3/8
wąż: 12mm

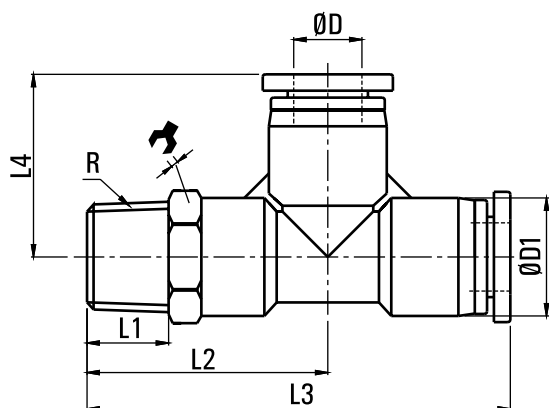

MODEL	ØD	R	L1	L2	L3	L4	ØD1	↻
PST-04-M5	4	M5	3.5	21.3	40.3	19	11.5	10
PST-04-01	4	1/8"	7.5	23.8	42.8	19	11.5	10
PST-04-02	4	1/4"	9.5	26.8	45.8	19	11.5	14
PST-04-03	4	3/8"	10.5	28.3	47.3	19	11.5	17
PST-06-M5	6	M5	3.5	21.7	40.9	19.2	13.5	12
PST-06-01	6	1/8"	7.5	24.2	43.4	19.2	13.5	12
PST-06-02	6	1/4"	9.5	26.7	46	19.2	13.5	14
PST-06-03	6	3/8"	10.5	28.2	47.5	19.2	13.5	17
PST-06-04	6	1/2"	13.5	31.7	51	19.2	13.5	21
PST-08-01	8	1/8"	7.5	27.5	50	22.5	15	14
PST-08-02	8	1/4"	9.5	29.5	52	22.5	15	14
PST-08-03	8	3/8"	10.5	31	53.5	22.5	15	17
PST-08-04	8	1/2"	13.5	34.5	57	22.5	15	21

MODEL	ØD	R	L1	L2	L3	L4	ØD1	↻
PST-10-01	10	1/8"	7.5	33	61.5	27.5	19	17
PST-10-02	10	1/4"	9.5	35	63.5	27.5	19	17
PST-10-03	10	3/8"	10.5	36	64.5	27.5	19	17
PST-10-04	10	1/2"	13.5	39.5	68	27.5	19	21
PST-12-01	12	1/8"	7.5	33.5	63	29.5	21.5	21
PST-12-02	12	1/4"	9.5	36	65.5	29.5	21.5	21
PST-12-03	12	3/8"	10.5	37	66.5	29.5	21.5	21
PST-12-04	12	1/2"	13.5	40	69.5	29.5	21.5	21