

Trójnik Y 06mm PY-06



hitech

model	PU-PY-06
producent	Hi-Tech
wąż	Ø 6 mm
typ	trójnik Y

typ szybkozłączki: trójnik Y
wąż: 6mm

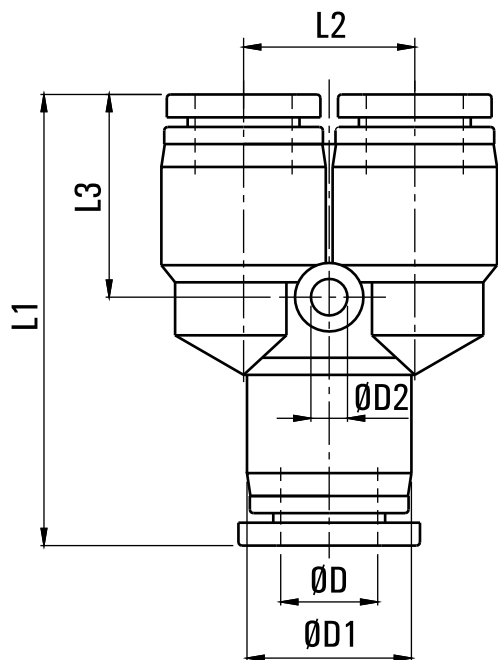

MODEL	ØD	ØD1	ØD2	L1	L2	L3
PY-04	4	11.5	3.2	36.5	11	14.5
PY-06	6	13.5	3.2	37.5	13	15
PY-08	8	15	3.2	39.8	15	18
PY-10	10	19	4.2	50	18	21
PY-12	12	21.5	4.2	53	21	21.5
PY-16	16	26.5	4.3	58.5	25	22