

Złączka kątowa PL-16-04



hitech

model	PU-PL-16-04
producent	Hi-Tech
wąż	Ø 16 mm
typ	kolanko
przyłącze	G 1/2
rodzaj gwintu	zewnątrzny

typ szybkozłączki: kolanko

przyłącze: 1/2

wąż: 16mm

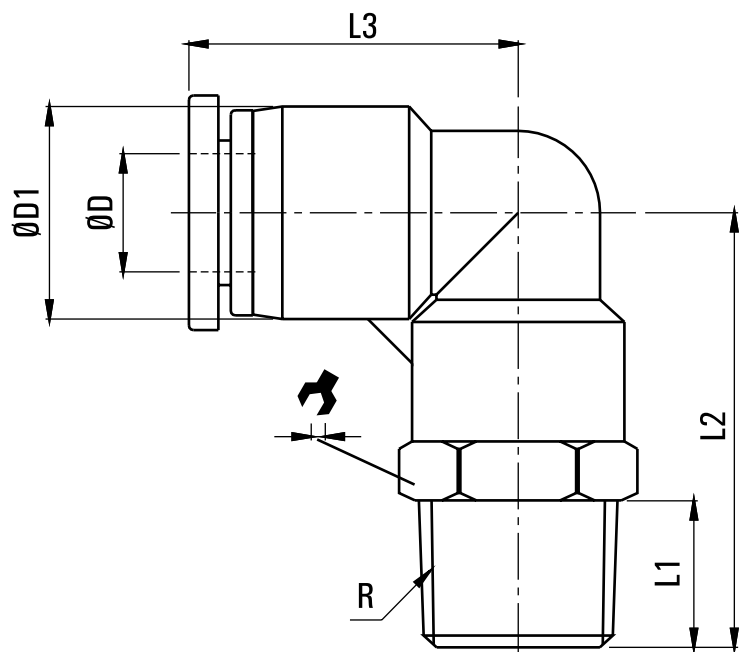

MODEL	ØD	R	L1	L2	L3	ØD1	↻
PL-04-M5	4	M5	3.5	21.3	19	11.5	10
PL-04-01	4	1/8"	7.5	23.8	19	11.5	10
PL-04-02	4	1/4"	9.5	26.8	19	11.5	14
PL-04-03	4	3/8"	10.5	28.3	19	11.5	17
PL-06-M5	6	M5	3.5	21.7	19.2	13.5	12
PL-06-01	6	1/8"	7.5	24.2	19.2	13.5	12
PL-06-02	6	1/4"	9.5	26.7	19.2	13.5	14
PL-06-03	6	3/8"	10.5	28.2	19.2	13.5	17
PL-08-01	8	1/8"	7.5	27.5	22.5	15	14
PL-08-02	8	1/4"	9.5	29.5	22.5	15	14
PL-08-03	8	3/8"	10.5	31	22.5	15	17
PL-08-04	8	1/2"	13.5	34.5	22.5	15	21

MODEL	ØD	R	L1	L2	L3	ØD1	↻
PL-10-01	10	1/8"	7.5	32.3	27.8	19	17
PL-10-02	10	1/4"	9.5	34.3	27.8	19	17
PL-10-03	10	3/8"	10.5	35.3	27.8	19	17
PL-10-04	10	1/2"	13.5	38.8	27.8	19	21
PL-12-01	12	1/8"	7.5	33.5	29.5	21.5	21
PL-12-02	12	1/4"	9.5	36	29.5	21.5	21
PL-12-03	12	3/8"	10.5	37	29.5	21.5	21
PL-12-04	12	1/2"	13.5	40	29.5	21.5	21
PL-16-03	16	3/8"	10.5	44	33	26.5	24
PL-16-04	16	1/2"	13.5	47	33	26.5	24