

Złączka kątowa PLL-08-01



hitech

model	PU-PLL-08-01
producent	Hi-Tech
wąż	Ø 8 mm
typ	kolanko
przyłącze	G 1/8
rodzaj gwintu	zewnątrzny

typ szybkozłączki: kolanko przedłużone

przyłącze: 1/8

wąż: 8 mm

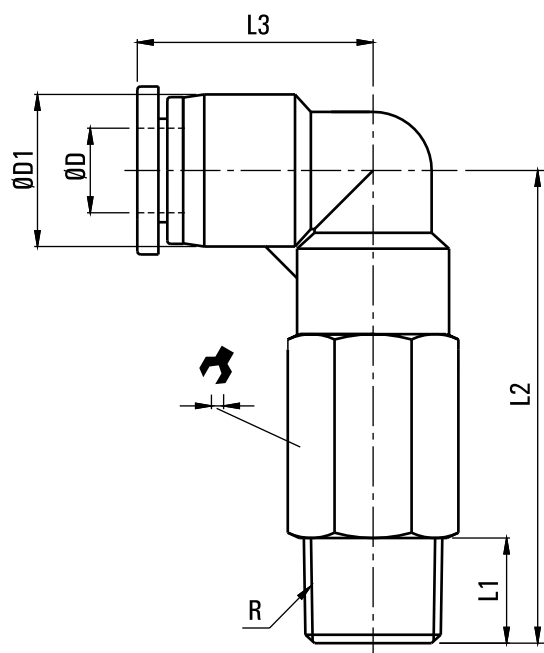

MODEL	ØD	R	L1	L2	L3	ØD1	⚙
PLL-04-M5	4	M5	3.5	33.3	19	11.5	10
PLL-04-01	4	1/8"	7.5	35.8	19	11.5	10
PLL-04-02	4	1/4"	9.5	38.8	19	11.5	14
PLL-04-03	4	3/8"	10.5	40.3	19	11.5	17
PLL-06-M5	6	M5	3.5	35	19.2	13.5	12
PLL-06-01	6	1/8"	7.5	38.2	19.2	13.5	12
PLL-06-02	6	1/4"	9.5	40.7	19.2	13.5	14
PLL-06-03	6	3/8"	10.5	42.2	19.2	13.5	17
PLL-08-01	8	1/8"	7.5	42.8	22.5	15	14
PLL-08-02	8	1/4"	9.5	44.8	22.5	15	14
PLL-08-03	8	3/8"	10.5	46.4	22.5	15	17
PLL-08-04	8	1/2"	13.5	48.8	22.5	15	21

MODEL	ØD	R	L1	L2	L3	ØD1	⚙
PLL-10-01	10	1/8"	7.5	52.3	27.8	19	17
PLL-10-02	10	1/4"	9.5	54.3	27.8	19	17
PLL-10-03	10	3/8"	10.5	55.3	27.8	19	17
PLL-10-04	10	1/2"	13.5	58.8	27.8	19	21
PLL-12-01	12	1/8"	7.5	57	29.5	21.5	21
PLL-12-02	12	1/4"	9.5	59	29.5	21.5	21
PLL-12-03	12	3/8"	10.5	60	29.5	21.5	21
PLL-12-04	12	1/2"	13.5	63	29.5	21.5	21