

Złączka kątowa redukcyjna 10-8



hitech

model	PU-PLGJ-10-08
producent	Hi-Tech
wąż	Ø 10 mm
wąż (r)	Ø 8 mm
typ	kolanko, redukcja

typ: złączka kątowa

wąż: 10mm

wąż: 8mm

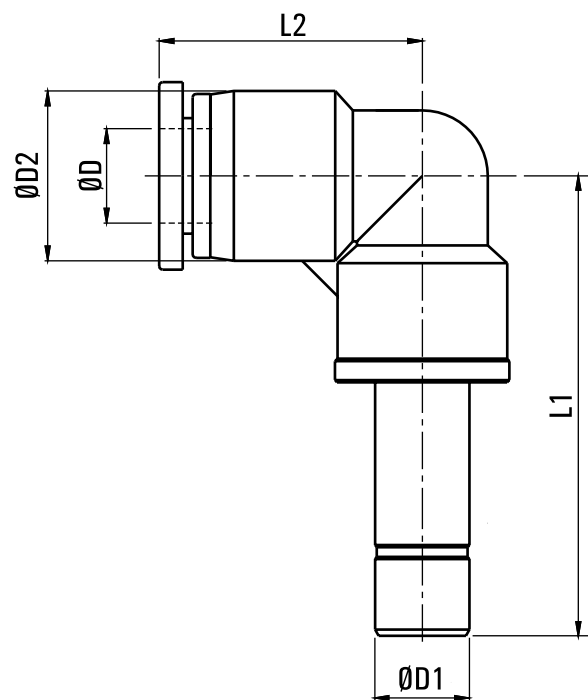

MODEL	ØD	ØD1	ØD2	L1	L2
PLGJ-06-04	4	6	11.5	34	19
PLGJ-08-06	6	8	13.5	35.7	19.2
PLGJ-10-08	8	10	15	42.5	22.5
PLGJ-12-10	10	12	19	48.3	27.8