

Złączka kątowa z zaworem odcinającym 1/4 - 8mm



hitech

model	PU-SPL-08-02
producent	Hi-Tech
wąż	Ø 8 mm
typ	kolanko, z zaworem
przyłącze	G 1/4
rodzaj gwintu	zewnątrzny
typ zaworu	odcinający

przyłącze: 1/4
wąż: 8mm

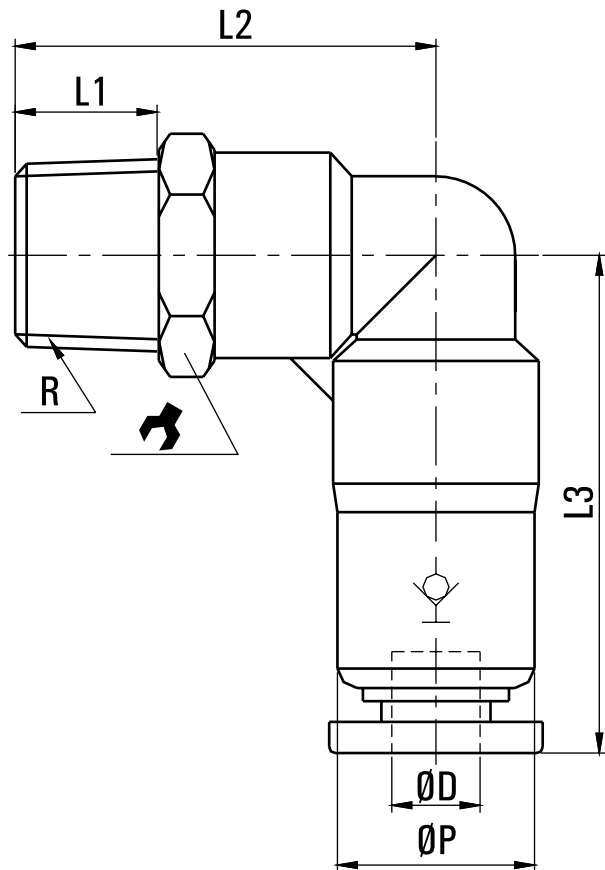

MODEL	ØD	R	L1	L2	L3	ØP	
SPL-04-M5	4	M5	3.5	21.3	31	13	10
SPL-04-01	4	1/8"	7.5	23.8	31	13	10
SPL-06-M5	6	M5	3.5	21.7	29.4	13	12
SPL-06-01	6	1/8"	7.5	24.2	29.4	13	12
SPL-06-02	6	1/4"	9.5	26.7	29.4	13	12
SPL-08-01	8	1/8"	7.5	27.5	33	14.5	14
SPL-08-02	8	1/4"	9.5	29.5	33	14.5	14
SPL-08-03	8	3/8"	10.5	31	33	14.5	14
SPL-10-02	10	1/4"	9.5	34.3	42.5	18	17
SPL-10-03	10	3/8"	10.5	35.3	42.5	18	17
SPL-10-04	10	1/2"	13.5	38.8	42.5	18	17
SPL-12-03	12	3/8"	10.5	37	46.5	21	21
SPL-12-04	12	1/2"	13.5	40	46.5	21	21