

Złączka rozgałęźna 2 X 8/6 – 3 X 6/4



hitech

model	PU-PKG-08-06
producent	Hi-Tech
wąż	Ø 8 mm
wąż (r)	Ø 6 mm
typ	wielozłączka

typ szybkozłączki: wielozłączka

wąż: 8mm

wąż: 6mm

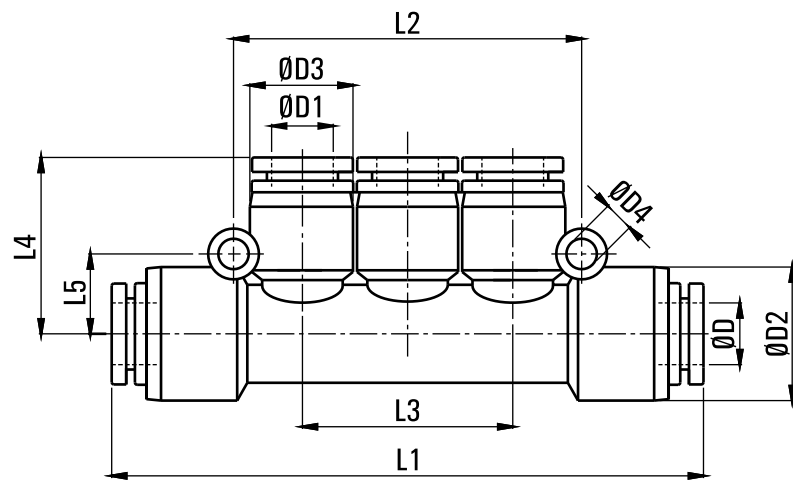

MODEL	ØD	ØD1	ØD2	ØD3	ØD4	L1	L2	L3	L4	L5
PKG-06-04	6	4	14.5	13	3.2	58	36	22	19	8
PKG-08-04	8	4	18.4	14.5	3.2	62	42	26	20.5	9
PKG-08-06	8	6	18.4	14.5	3.2	81	48	29	24.5	9
PKG-10-06	10	6	19	14.5	4.2	87	61	29	24.5	11.5
PKG-10-08	10	8	19	14.5	4.2	87	61	29	24.5	11.5