

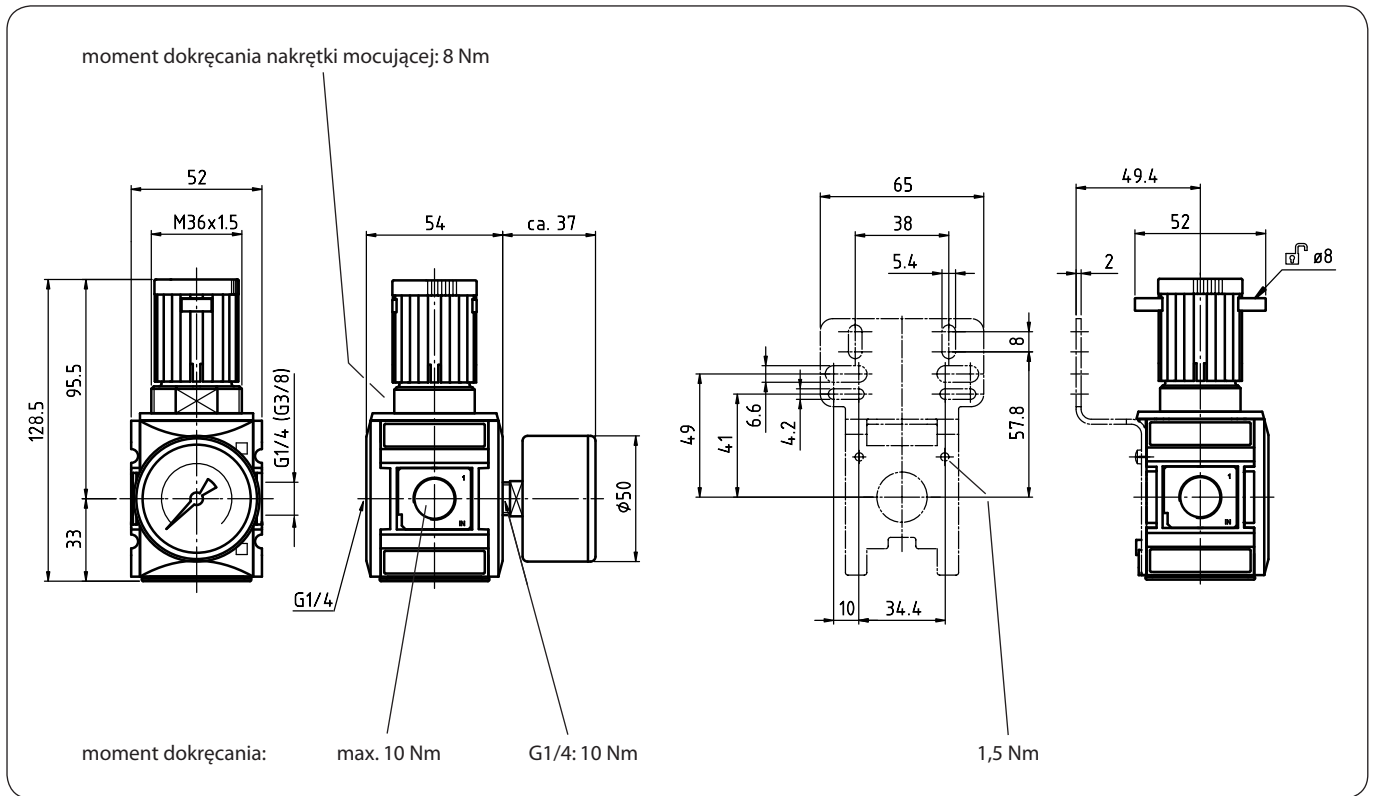

## wymiary (mm)

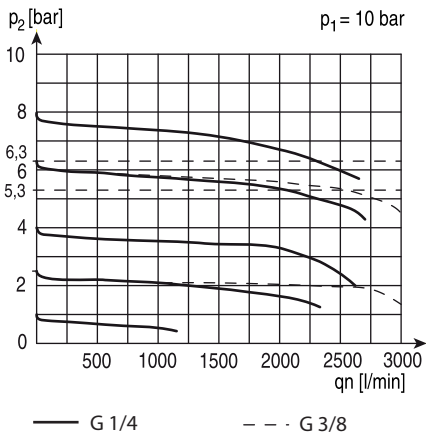

## charakterystyka przepływu



## charakterystyka ciśnienia

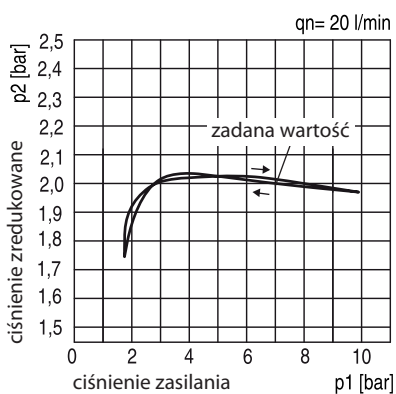

## akcesoria

2

### manometr

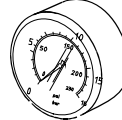

typ: G 50.2,5 R  
G 50.4 R  
G 50.6 R  
G 50.10 R  
G 50.16 R  
G 50.25 R

### sprężyna



typ:  
0,1-1: FED.1-700  
0,1-2: FED.1-701  
0,2-4: FED.1-702  
0,5-8: FED.1-703  
0,5-10: FED.1-704  
0,5-16: FED.1-705

### blokada

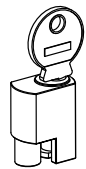

typ:  
VH.32 z kluczem  
VH.31 bez klucza

### zestaw montażowy na śruby

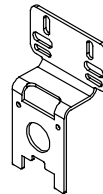

typ: KBW.1-1225

### zestaw montażowy do paneli



typ: KBW.1-1227

### nakrętka mocująca do paneli



typ: SM.1

### łącznik do bloków

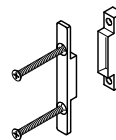

typ: KKOP.1

### łącznik do bloków z mocowaniem

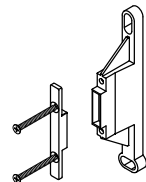

typ: KKOP.1W